



# SEALFAST

THE SIMPLE SOLUTION

## CONNECTIONS MADE SIMPLE!

019



COUPLINGS +  
FIRE  
PROTECTION  
GAUGES  
PIPE FITTINGS  
& VALVES  
HOSES  
SHEET  
RUBBER



**GET CONNECTED** [SEALFAST.COM](http://SEALFAST.COM)

SINCE 1933

ISO 9001-2015 Registered

**PRODUCT CATALOG**  
edition 019



38 CRIMP FERRULES

88 HYDRAULIC QUICK DISCONNECTS



231 4000 & 6000 PSI PRESSURE WASHER HOSE

209 NEEDLE VALVES

112 SEAL FAST PREFORMED CLAMPS

21 CAM & GROOVE ALUMINUM ELBOWS

194 HAMMER UNIONS



69 RING LOCKS (set)



206 BUTTERFLY VALVES

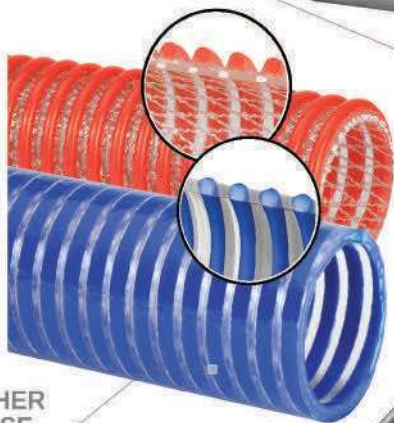

255 COLD WEATHER SUCTION HOSE

192 316 PIPE FITTINGS



205 DEADMAN VALVES

196 FLANGES





# CONTENTS



## COUPLINGS +

# 6-151

|                              |         |
|------------------------------|---------|
| CAM & GROOVE .....           | 6-33    |
| CRIMPING SYSTEM .....        | 34-41   |
| FUEL TANKER .....            | 42-57   |
| DRY DISCONNECTS .....        | 58-61   |
| SHANK .....                  | 62-65   |
| BAUER TYPE .....             | 66-68   |
| RING LOCK .....              | 69      |
| SANDBLAST .....              | 70-71   |
| GROUND JOINTS .....          | 72-73   |
| FOOT VALVES/ STRAINERS ..... | 74-75   |
| BRASS FITTINGS .....         | 76-81   |
| QUICK CONNECT .....          | 82-85   |
| HYDRAULICS .....             | 86-107  |
| CLAMPS .....                 | 108-126 |
| SAFETY .....                 | 127     |
| SHOP AID .....               | 128-141 |
| BANJO .....                  | 142-149 |

COUPLINGS +



## FIRE PROTECTION

# 152-167

|                                     |         |
|-------------------------------------|---------|
| NOZZLES .....                       | 150-155 |
| VALVES .....                        | 156-160 |
| COUPLINGS .....                     | 161     |
| ADAPTERS .....                      | 162-164 |
| STORZ .....                         | 165     |
| WRENCHES & INDUSTRIAL MONITORS..... | 166-167 |

FIRE PROTECTION



## GAUGES

# 170-179

|                         |         |
|-------------------------|---------|
| THERMOMETERS .....      | 170-171 |
| THERMOWELL .....        | 171     |
| GAUGES .....            | 172-178 |
| SIPHONS .....           | 178     |
| NEEDLE VALVES .....     | 179     |
| PRESSURE SNUBBERS ..... | 179     |

GAUGES



## PIPE FITTINGS / VALVES

# 182-211

|                           |         |
|---------------------------|---------|
| COMBINATION NIPPLES ..... | 182-187 |
| NIPPLES .....             | 188-190 |
| COUPLINGS .....           | 191     |
| FITTINGS .....            | 192-193 |
| HAMMER UNION .....        | 194-195 |
| FLANGES .....             | 196-199 |
| STUB ENDS .....           | 200-201 |
| VALVES .....              | 202-211 |

PIPE FITTINGS / VALVES



## HOSE / HOSE PROTECTION

# 212-288

|                              |         |
|------------------------------|---------|
| INDUSTRIAL RUBBER HOSE ..... | 212-243 |
| THERMOPLASTIC HOSE .....     | 244-269 |
| FIRE/MILL HOSE .....         | 270-281 |
| HYDRAULIC HOSE .....         | 282-285 |
| HOSE PROTECTION .....        | 286-288 |

HOSES



## SHEET RUBBER

# 292-299

|                    |         |
|--------------------|---------|
| MATTING .....      | 292     |
| SKIRTBOARD .....   | 293     |
| SHEET RUBBER ..... | 294-299 |

SHEET RUBBER

## TECHNICAL DATA & INDEX

|                      |         |
|----------------------|---------|
| TECHNICAL DATA ..... | 300-308 |
| INDEX .....          | 309-316 |



# TERMS OF SALE

COUPLINGS +

FIRE PROTECTION

GAUGES

PIPE FITTINGS/  
VALVES

HOSES

SHEET RUBBER

## TERMS:

1/2% 10 Days, net 30 Days

## FREIGHT:

All shipments are made FOB Seal Fast Inc. or Point of Manufacturer. (Applies to shipments from Houston Warehouse Only) Freight prepaid on 1000 net couplings and accessories, \$1500 Net Couplings, PVC Tubing, Braided Tubing and Fire Hose. Freight prepaid on \$3000 Net Couplings, Rubber Hose, PVC Hose and Sheet Rubber with the exclusion of all PVC Suction including 6" and 8" PVC Suction ONLY orders. If combined with other items freight is prepaid at \$3000 Net, otherwise these items will Not be applied toward prepaid freight. **Effective immediately, regardless of invoice value, all uncoupled cut lengths of hoses are shipped FOB Seal Fast Inc.** Seal Fast Inc. reserves the right to determine the most Economical shipping method on all prepaid shipments. **In addition, Seal Fast Inc. reserves the right to refuse any prepaid shipments exceeding 6% freight cost of the order unless items are added or subtracted to keep said freight cost at or below 6%.** Applies to Continental United States, excluding Alaska and Hawaii. **Any evidence of shortage must be reported to Seal Fast Inc. within 10 days. Any Damage to hose/hoses, etc. customer is responsible for filing a claim with the delivery carrier within 10 days. Seal Fast Inc. will not issue credit.**

ALL UPS prepay and add or collect shipments will endure a **\$7.50** shipping and handling fee including All backorders. All drop shipments will endure a \$5.00 fee.

## WARRANTY:

Products are warranted against defects in workmanship and defects in material. Products having such defects will be replaced or credited as Seal Fast elects. Liability is limited to the invoice value of the defective item. Our responsibility shall not exceed the original purchase price of the defective product. In any event, Seal Fast, Inc. shall not be held responsible for any special or consequential damages.

## RETURNED GOODS:

If for any reason you wish to return goods, please contact Seal Fast Inc. for prior authorization number. Goods must be returned within 30 days and must be in new and resaleable condition. Minimum handling charge is 15%.

**All discrepancies in shipment / invoice must be reported within 10 days of receipt of goods.**

## PROMPTPAYMENT:

Orders receive preferred treatment when the account is paid promptly. Orders may be held up if any unpaid invoice exceeds 30 days.

## MINIMUM INVOICE:

All invoices are subject to a minimum billing charge of 50.00 net. Returned checks are subject to a \$25.00 service charge.

## GENERAL:

Orders will be accepted subject to delays caused by accident, strike, fire or other causes beyond the control of the seller including failure of seller's suppliers to deliver. Prices, discounts and other specifications are subject to change without notice. All prices are subject to any applicable taxes imposed. The possessions of this price schedule is not to be construed as an offer to sell at the prices shown. Special price for volume quotes will be accepted in writing only.

## PLEASE NOTE:

Extra care is taken in the preparation of this literature but Seal Fast, Inc. is not responsible for any inadvertent typographical errors or omissions.

## STOCKING WAREHOUSES



## DISCLAIMERS

### Product Images

- Seal Fast makes every reasonable effort to show accurate product representation, however pictures are for reference only, and do not necessarily reflect the exact product you will receive.
- Seal Fast reserves the right to alter product appearance without notice. Some product features shown in pictures may no longer be available.

### Product Specifications

- Seal Fast is continuously working to provide the best quality for the best price.
- We reserve the right to alter product specifications without notice.

### Product Usage

- Our Sales Team will do their best to assist in choosing the best product for a particular application. However, it is ultimately the customer's responsibility to determine the correct product for the correct application.
- Seal Fast will not be held liable for the abuse or misuse of our products in a manner in which they are not designed.
- Seal Fast cannot guarantee the integrity of an assembly if other manufacturers parts are used.

### Product Availability

- Seal Fast reserves the right to discontinue products at any time without prior notice.

### Product Pricing

- Seal Fast is constantly doing our best to maintain pricing levels. However, circumstances change and while many prices go down, others will increase.
- Please contact your sales associate for current pricing.



# WELCOME TO SEALFAST

COUPLINGS +

FIRE PROTECTION

GAUGES

PIPE FITTINGS/  
VALVES

HOSES

SHEET RUBBER



# THE SIMI SOLUT

COUPLINGS | HOSES |  
VALVES | GAUGES | CLAMPS |  
FITTINGS | HYDRAULIC | STRAINERS |  
SHEET RUBBER | SHOP AIDS





COUPLINGS +

FIRE PROTECTION

GAUGES

PIPE FITTINGS/  
VALVES

HOSES

SHEET RUBBER



# PLE TION





# CAM & GROOVE COUPLINGS

COUPLINGS +

# SEALFAST

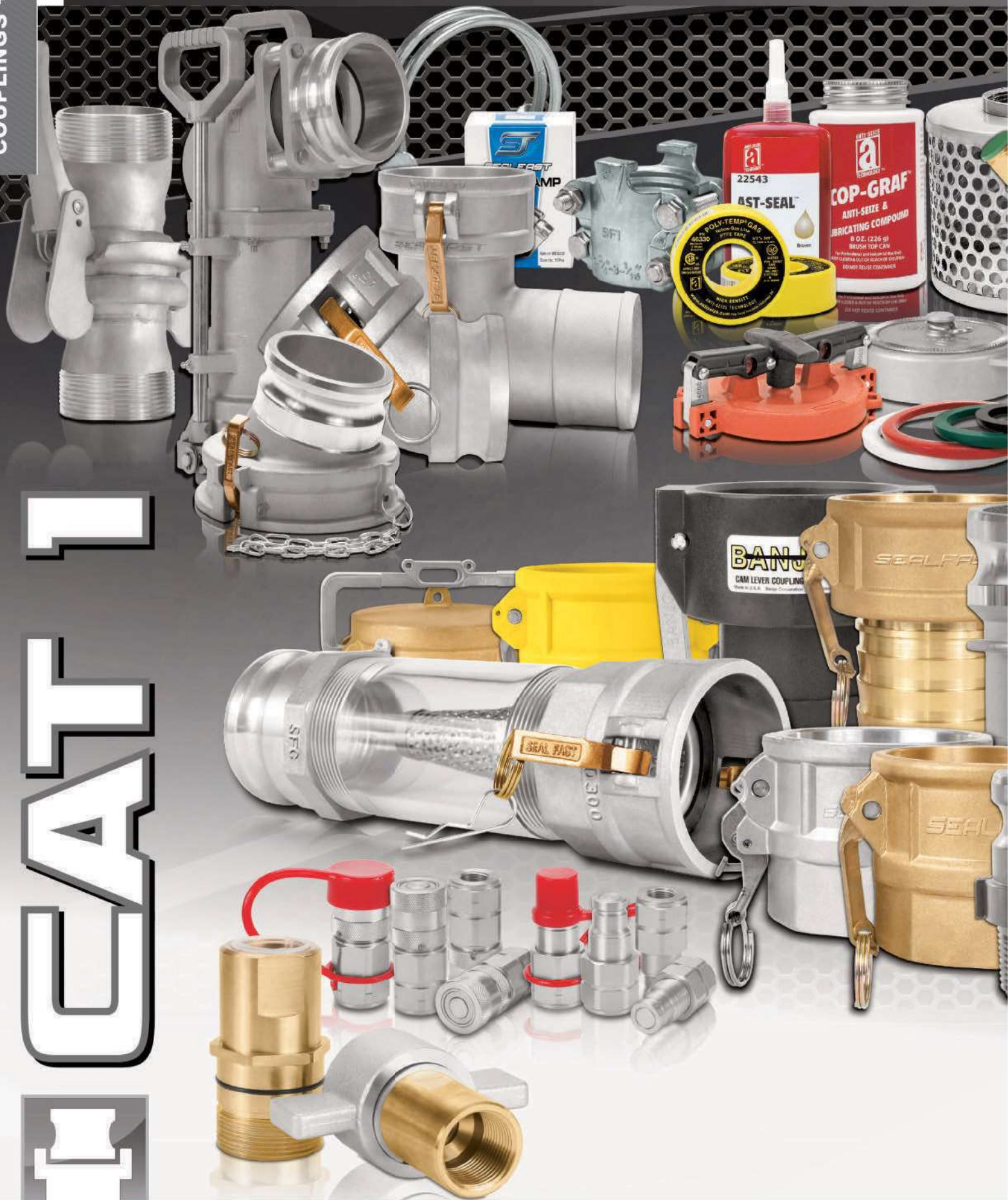



## INDEX

- 1 CAM & GROOVE ..... 6-33
- 2 CRIMPING SYSTEM ..... 34-41
- 3 FUEL TANKER ..... 42-57
- 4 DRY DISCONNECTS ..... 58-61
- 5 SHANK ..... 62-65
- 6 BAUER TYPE ..... 66-68
- 7 RING LOCK ..... 69
- 8 SANDBLAST ..... 70-71
- 9 GROUND JOINTS ..... 72-73
- 10 FOOT VALVES / STRAINERS ..... 74-75
- 11 BRASS FITTINGS ..... 76-81
- 12 QUICK CONNECT ..... 82-85
- 13 HYDRAULIC FITTINGS ..... 86-107
- 14 CLAMPS ..... 108-126
- 15 SAFTEY ..... 127
- 16 SHOP AIDS ..... 128-141
- 17 BANJO ..... 142-149





# CAM & GROOVE COUPLINGS

## FEMALE NPT X MALE ADAPTER

COUPLINGS +



| Size       | ALUMINUM      |      | BRASS      |      | 316 SS    |      | 304 SS     |      |
|------------|---------------|------|------------|------|-----------|------|------------|------|
|            | Part #        | List | Part #     | List | Part #    | List | Part #     | List |
| 1/2"       | A 050IAL      |      | A 050IBR   |      | A 050SS   |      | A 050SS304 |      |
| 1/2 x 3/4" | A 05075IAL    |      | A 05075IBR |      | A 05075SS |      | --         | --   |
| 3/4"       | A 075IAL      |      | A 075IBR   |      | A 075SS   |      | A 075SS304 |      |
| 1"         | A 100IAL      |      | A 100IBR   |      | A 100SS   |      | A 100SS304 |      |
| 1-1/4"     | A 125IAL      |      | A 125IBR   |      | A 125SS   |      | A 125SS304 |      |
| 1-1/2"     | A 150IAL      |      | A 150IBR   |      | A 150SS   |      | A 150SS304 |      |
| 2"         | A 200IAL      |      | A 200IBR   |      | A 200SS   |      | A 200SS304 |      |
| 2-1/2"     | A 250IAL      |      | A 250IBR   |      | A 250SS   |      | A 250SS304 |      |
| 3"         | A 300IAL      |      | A 300IBR   |      | A 300SS   |      | A 300SS304 |      |
| 4"         | A 400IAL      |      | A 400IBR   |      | A 400SS   |      | A 400SS304 |      |
| 5"         | A500ASTMAL    |      | A500ASTMBR |      | A 500SS   |      | A 500SS304 |      |
| 6"         | A 600IAL      |      | A 600IBR   |      | A 600SS   |      | A 600SS304 |      |
| 8"         | A 800IALNAE*  |      | --         |      | --        |      | --         |      |
| 8"         | A 800IALPTK** |      | --         |      | --        |      | --         |      |
| 10"        | A 1000IAL     |      | --         |      | --        |      | --         |      |
| 12"        | A 1200IAL     |      | --         |      | --        |      | --         |      |

\*NAE is "Large Body" - \*\*PTK is "Small Body"

TYPE  
**A**



| Size       | PLATED IRON |      | POLYPROPYLENE |      | NYGLASS      |      |
|------------|-------------|------|---------------|------|--------------|------|
|            | Part #      | List | Part #        | List | Part #       | List |
| 1/2 x 3/4" | ---         |      | A 050075PP    |      | ---          | ---  |
| 3/4"       | ---         |      | A 075PP       |      | A 075NG      |      |
| 1"         | A 100CI     |      | A 100PP       |      | A 100NG      |      |
| 1-1/4"     | ---         |      | A 125125PP    |      | **A 125125NG |      |
| 1-1/2"     | A 150CI     |      | A 150PP       |      | **A 150NG    |      |
| 2"         | A 200CI     |      | A 200PP       |      | A 200NG      |      |
| 3"         | A 300CI     |      | A 300PP       |      | A 300NG      |      |
| 4"         | A 400CI     |      | A 400PP       |      | A 400NG      |      |
| 5"         | A 500CI     |      | ---           |      | ---          |      |
| 6"         | A 600CI     |      | ---           |      | ---          |      |



# CAM & GROOVE COUPLINGS

## FEMALE COUPLER X MALE NPT

► All Couplers Supplied with Buna-N Gaskets



| Size       | ALUMINUM      |      | BRASS       |      | 316 SS    |      | 304 SS     |      |
|------------|---------------|------|-------------|------|-----------|------|------------|------|
|            | Part #        | List | Part #      | List | Part #    | List | Part #     | List |
| 1/2"       | B 050IAL      |      | B 050IBR    |      | B 050SS   |      | B 050SS304 |      |
| 1/2 x 3/4" | B 05075IAL    |      | B 05075IBR  |      | B 05075SS |      | --         | --   |
| 3/4"       | B 075IAL      |      | B 075IBR    |      | B 075SS   |      | B 075SS304 |      |
| 1"         | B 100IAL      |      | B 100IBR    |      | B 100SS   |      | B 100SS304 |      |
| 1-1/4"     | B 125IAL      |      | B 125IBR    |      | B 125SS   |      | B 125SS304 |      |
| 1-1/2"     | B 150IAL      |      | B 150IBR    |      | B 150SS   |      | B 150SS304 |      |
| 2"         | B 200IAL      |      | B 200IBR    |      | B 200SS   |      | B 200SS304 |      |
| 2-1/2"     | B 250IAL      |      | B 250IBR    |      | B 250SS   |      | B 250SS304 |      |
| 3"         | B 300IAL      |      | B 300IBR    |      | B 300SS   |      | B 300SS304 |      |
| 4"         | B 400IAL      |      | B 400IBR    |      | B 400SS   |      | B 400SS304 |      |
| 5"         | B 500ASTMAL   |      | B 500ASTMBR |      | B 500SS   |      | B 500SS304 |      |
| 6"         | B 600IAL      |      | B 600IBR    |      | B 600SS   |      | B 600SS304 |      |
| 8"         | B 800IALNAE*  |      | --          |      | --        |      | --         |      |
| 8"         | B 800IALPTK** |      | --          |      | --        |      | --         |      |

\*NAE is "Large Body" - \*\*PTK is "Small Body"

# TYPE B



| Size       | PLATED IRON |      | POLYPROPYLENE |      | NYGLASS      |      |
|------------|-------------|------|---------------|------|--------------|------|
|            | Part #      | List | Part #        | List | Part #       | List |
| 1/2 x 3/4" | --          | --   | B 050075PP    |      | --           | --   |
| 3/4"       | --          | --   | B 075PP       |      | B 075NG      |      |
| 1"         | B 100CI     |      | B 100PP       |      | B 100NG      |      |
| 1-1/4"     | --          | --   | **B 125125PP  |      | **B 125125NG |      |
| 1-1/2"     | B 150CI     |      | **B 150PP     |      | **B 150NG    |      |
| 2"         | B 200CI     |      | B 200PP       |      | B 200NG      |      |
| 3"         | B 300CI     |      | B 300PP       |      | B 300NG      |      |
| 4"         | B 400CI     |      | B 400PP       |      | B 400NG      |      |
| 5"         | B 500CI     |      | --            |      | --           |      |
| 6"         | B 600CI     |      | --            |      | --           |      |





# CAM & GROOVE COUPLINGS

## FEMALE COUPLER X SHANK

▶ All Couplers Supplied with Buna-N Gaskets



| Size       | ALUMINUM      |      | BRASS      |      | 316 SS    |      | 304 SS     |      |
|------------|---------------|------|------------|------|-----------|------|------------|------|
|            | Part #        | List | Part #     | List | Part #    | List | Part #     | List |
| 1/2"       | C 050IAL      |      | C 050IBR   |      | C 050SS   |      | C 050SS304 |      |
| 1/2 x 3/4" | C 05075IAL    |      | C 05075IBR |      | C 05075SS |      | --         | --   |
| 3/4"       | C 075IAL      |      | C 075IBR   |      | C 075SS   |      | C 075SS304 |      |
| 1"         | C 100IAL      |      | C 100IBR   |      | C 100SS   |      | C 100SS304 |      |
| 1-1/4"     | C 125IAL      |      | C 125IBR   |      | C 125SS   |      | C 125SS304 |      |
| 1-1/2"     | C 150IAL      |      | C 150IBR   |      | C 150SS   |      | C 150SS304 |      |
| 2"         | C 200IAL      |      | C 200IBR   |      | C 200SS   |      | C 200SS304 |      |
| 2-1/2"     | C 250IAL      |      | C 250IBR   |      | C 250SS   |      | C 250SS304 |      |
| 3"         | C 300IAL      |      | C 300IBR   |      | C 300SS   |      | C 300SS304 |      |
| 4"         | C 400IAL      |      | C 400IBR   |      | C 400SS   |      | C 400SS304 |      |
| 5"         | C500ASTMAL    |      | C500ASTMBR |      | C 500SS   |      | C 500SS304 |      |
| 6"         | C 600IAL      |      | C 600IBR   |      | C 600SS   |      | C 600SS304 |      |
| 8"         | C 800IALNAE*  |      | --         |      | --        |      | --         |      |
| 8"         | C 800IALPTK** |      | --         |      | --        |      | --         |      |
| 10"        | C 1000IAL     |      | --         |      | --        |      | --         |      |
| 12"        | C 1200IAL     |      | --         |      | --        |      | --         |      |

\*NAE is "Large Body" - \*\*PTK is "Small Body"



| Size       | PLATED IRON |      | POLYPROPYLENE |      | NYGLASS      |      |
|------------|-------------|------|---------------|------|--------------|------|
|            | Part #      | List | Part #        | List | Part #       | List |
| 1/2 x 3/4" | --          |      | C 050075PP    |      | --           | --   |
| 3/4"       | --          |      | C 075PP       |      | C 075NG      |      |
| 1"         | C 100CI     |      | C 100PP       |      | C 100NG      |      |
| 1-1/4"     | --          |      | **C 125125PP  |      | **C 125125NG |      |
| 1-1/2"     | C 150CI     |      | **C 150PP     |      | **C 150NG    |      |
| 2"         | C 200CI     |      | C 200PP       |      | C 200NG      |      |
| 3"         | C 300CI     |      | C 300PP       |      | C 300NG      |      |
| 4"         | C 400CI     |      | C 400PP       |      | C 400NG      |      |
| 5"         | C 500CI     |      | --            |      | --           |      |
| 6"         | C 600CI     |      | --            |      | --           |      |

\*\* Available as: 1-1/4 adapter or coupler X 1-1/4 NPT | Please specify: 1-1/2 adapter or coupler X 1-1/4 NPT | 1-1/2 adapter or coupler X 1-1/2 NPT  
\*1/2 - 1 1/2 Aluminum Cam Lock may not have a machined shank





# CAM & GROOVE COUPLINGS

## FEMALE COUPLER X FEMALE NPT

▶ All Couplers Supplied with Buna-N Gaskets



COUPLINGS + 

| Size       | ALUMINUM      |      | BRASS       |      | 316 SS    |      | 304 SS     |      |
|------------|---------------|------|-------------|------|-----------|------|------------|------|
|            | Part #        | List | Part #      | List | Part #    | List | Part #     | List |
| 1/2"       | D 050IAL      |      | D 050IBR    |      | D 050SS   |      | D 050SS304 |      |
| 1/2 x 3/4" | D 05075IAL    |      | D 05075IBR  |      | D 05075SS |      | --         | --   |
| 3/4"       | D 075IAL      |      | D 075IBR    |      | D 075SS   |      | D 075SS304 |      |
| 1"         | D 100IAL      |      | D 100IBR    |      | D 100SS   |      | D 100SS304 |      |
| 1-1/4"     | D 125IAL      |      | D 125IBR    |      | D 125SS   |      | D 125SS304 |      |
| 1-1/2"     | D 150IAL      |      | D 150IBR    |      | D 150SS   |      | D 150SS304 |      |
| 2"         | D 200IAL      |      | D 200IBR    |      | D 200SS   |      | D 200SS304 |      |
| 2-1/2"     | D 250IAL      |      | D 250IBR    |      | D 250SS   |      | D 250SS304 |      |
| 3"         | D 300IAL      |      | D 300IBR    |      | D 300SS   |      | D 300SS304 |      |
| 4"         | D 400IAL      |      | D 400IBR    |      | D 400SS   |      | D 400SS304 |      |
| 5"         | D500ASTMAL    |      | D 500ASTMBR |      | D 500SS   |      | D 500SS304 |      |
| 6"         | D 600IAL      |      | D 600IBR    |      | D 600SS   |      | D 600SS304 |      |
| 8"         | D 800IALNAE*  |      | --          |      | --        |      | --         |      |
| 8"         | D 800IALPTK** |      | --          |      | --        |      | --         |      |
| 10"        | D 1000IAL     |      | --          |      | --        |      | --         |      |
| 12"        | D 1200IAL     |      | --          |      | --        |      | --         |      |

\*NAE is "Large Body" - \*\*PTK is "Small Body"

TYPE **D**



| Size       | PLATED IRON |      | POLYPROPYLENE |      | NYGLASS   |      |
|------------|-------------|------|---------------|------|-----------|------|
|            | Part #      | List | Part #        | List | Part #    | List |
| 1/2 x 3/4" | ---         |      | D 050075PP    |      | ---       |      |
| 3/4"       | ---         |      | D 075PP       |      | D 075NG   |      |
| 1"         | D 100CI     |      | D 100PP       |      | D 100NG   |      |
| 1-1/4"     | ---         |      | D 125125PP    |      | **D 125NG |      |
| 1-1/2"     | D 150CI     |      | D 150PP       |      | **D 150NG |      |
| 2"         | D 200CI     |      | D 200PP       |      | D 200NG   |      |
| 3"         | D 300CI     |      | D 300PP       |      | D 300NG   |      |
| 4"         | D 400CI     |      | D 400PP       |      | D 400NG   |      |
| 5"         | D 500CI     |      | ---           |      | ---       |      |
| 6"         | D 600CI     |      | ---           |      | ---       |      |

\*\* Available as: 1-1/4 adapter or coupler X 1-1/4 NPT | Please specify: 1-1/2 adapter or coupler X 1-1/4 NPT | 1-1/2 adapter or coupler X 1-1/2 NPT  
 Note: All Seal Fast Cam & Groove Stainless Bodies are 316 Investment with 304 Handles. \* Dust Caps and Dust Plugs are not designed for pressure applications.



# CAM & GROOVE COUPLINGS

## MALE ADAPTER X SHANK

COUPLINGS +



| Size       | ALUMINUM      |      | BRASS       |      | 316 SS    |      | 304 SS     |      |
|------------|---------------|------|-------------|------|-----------|------|------------|------|
|            | Part #        | List | Part #      | List | Part #    | List | Part #     | List |
| 1/2"       | E 050IAL      |      | E 050IBR    |      | E 050SS   |      | E 050SS304 |      |
| 1/2 x 3/4" | E 05075IAL    |      | E 05075IBR  |      | E 05075SS |      | --         |      |
| 3/4"       | E 075IAL      |      | E 075IBR    |      | E 075SS   |      | E 075SS304 |      |
| 1"         | E 100IAL      |      | E 100IBR    |      | E 100SS   |      | E 100SS304 |      |
| 1-1/4"     | E 125IAL      |      | E 125IBR    |      | E 125SS   |      | E 125SS304 |      |
| 1-1/2"     | E 150IAL      |      | E 150IBR    |      | E 150SS   |      | E 150SS304 |      |
| 2"         | E 200IAL      |      | E 200IBR    |      | E 200SS   |      | E 200SS304 |      |
| 2-1/2"     | E 250IAL      |      | E 250IBR    |      | E 250SS   |      | E 250SS304 |      |
| 3"         | E 300IAL      |      | E 300IBR    |      | E 300SS   |      | E 300SS304 |      |
| 4"         | E 400IAL      |      | E 400IBR    |      | E 400SS   |      | E 400SS304 |      |
| 5"         | E 500ASTMAL   |      | E 500ASTMBR |      | E 500SS   |      | E 500SS304 |      |
| 6"         | E 600IAL      |      | E 600IBR    |      | E 600SS   |      | E 600SS304 |      |
| 8"         | E 800IALNAE*  |      | --          |      | --        |      | --         |      |
| 8"         | E 800IALPTK** |      | --          |      | --        |      | --         |      |
| 10"        | E 1000IAL     |      | --          |      | --        |      | --         |      |
| 12"        | E 1200IAL     |      | --          |      | --        |      | --         |      |

\*NAE is "Large Body" - \*\*PTK is "Small Body"



TYPE

| Size       | PLATED IRON |      | POLYPROPYLENE |      | NYGLASS      |      |
|------------|-------------|------|---------------|------|--------------|------|
|            | Part #      | List | Part #        | List | Part #       | List |
| 1/2 x 3/4" | --          |      | E 050075PP    |      | --           |      |
| 3/4"       | --          |      | E 075PP       |      | E 075NG      |      |
| 1"         | E 100CI     |      | E 100PP       |      | E 100NG      |      |
| 1-1/4"     | --          |      | E 125125PP    |      | **E 125125NG |      |
| 1-1/2"     | E 150CI     |      | E 150PP       |      | **E 150NG    |      |
| 2"         | E 200CI     |      | E 200PP       |      | E 200NG      |      |
| 3"         | E 300CI     |      | E 300PP       |      | E 300NG      |      |
| 4"         | E 400CI     |      | E 400PP       |      | E 400NG      |      |
| 5"         | E 500CI     |      | --            |      | --           |      |
| 6"         | E 600CI     |      | --            |      | --           |      |

\*1/2 - 1 1/2 Aluminum Cam Lock may not have a machined shank



# CAM & GROOVE COUPLINGS

## MALE ADAPTER X MALE NPT

COUPLINGS +



| Size       | ALUMINUM      |      | BRASS       |      | 316 SS    |      | 304 SS     |      |
|------------|---------------|------|-------------|------|-----------|------|------------|------|
|            | Part #        | List | Part #      | List | Part #    | List | Part #     | List |
| 1/2"       | F 050IAL      |      | F 050IBR    |      | F 050SS   |      | F 050SS304 |      |
| 1/2 x 3/4" | F 05075IAL    |      | F 05075IBR  |      | F 05075SS |      | --         |      |
| 3/4"       | F 075IAL      |      | F 075IBR    |      | F 075SS   |      | F 075SS304 |      |
| 1"         | F 100IAL      |      | F 100IBR    |      | F 100SS   |      | F 100SS304 |      |
| 1-1/4"     | F 125IAL      |      | F 125IBR    |      | F 125SS   |      | F 125SS304 |      |
| 1-1/2"     | F 150IAL      |      | F 150IBR    |      | F 150SS   |      | F 150SS304 |      |
| 2"         | F 200IAL      |      | F 200IBR    |      | F 200SS   |      | F 200SS304 |      |
| 2-1/2"     | F 250IAL      |      | F 250IBR    |      | F 250SS   |      | F 250SS304 |      |
| 3"         | F 300IAL      |      | F 300IBR    |      | F 300SS   |      | F 300SS304 |      |
| 4"         | F 400IAL      |      | F 400IBR    |      | F 400SS   |      | F 400SS304 |      |
| 5"         | F 500ASTMAL   |      | F 500ASTMBR |      | F 500SS   |      | F 500SS304 |      |
| 6"         | F 600IAL      |      | F 600IBR    |      | F 600SS   |      | F 600SS304 |      |
| 8"         | F 800IALNAE*  |      | --          |      | --        |      | --         |      |
| 8"         | F 800IALPTK** |      | --          |      | --        |      | --         |      |
| 10"        | F 1000IAL     |      | --          |      | --        |      | --         |      |
| 12"        | F 1200IAL     |      | --          |      | --        |      | --         |      |

\*NAE is "Large Body" - \*\*PTK is "Small Body"

TYPE F



| Size       | PLATED IRON |      | POLYPROPYLENE |      | NYGLASS      |      |
|------------|-------------|------|---------------|------|--------------|------|
|            | Part #      | List | Part #        | List | Part #       | List |
| 1/2 x 3/4" | ---         |      | F 050075PP    |      | ---          |      |
| 3/4"       | ---         |      | F 075PP       |      | F 075NG      |      |
| 1"         | F 100CI     |      | F 100PP       |      | F 100NG      |      |
| 1-1/4"     | ---         |      | F 125125PP    |      | **F 125125NG |      |
| 1-1/2"     | F 150CI     |      | **F 150PP     |      | **F 150NG    |      |
| 2"         | F 200CI     |      | **F 200PP     |      | F 200NG      |      |
| 3"         | F 300CI     |      | F 300PP       |      | F 300NG      |      |
| 4"         | F 400CI     |      | F 400PP       |      | F 400NG      |      |
| 5"         | F 500CI     |      | ---           |      | ---          |      |
| 6"         | F 600CI     |      | ---           |      | ---          |      |

\*\* Available as: 1-1/4 adapter or coupler X 1-1/4 NPT | Please specify: 1-1/2 adapter or coupler X 1-1/4 NPT | 1-1/2 adapter or coupler X 1-1/2 NPT  
 Note: All Cam & Groove Stainless Bodies are 316 Investment with 304 Handles. All 4" Poly and Ny-Glass couplers have 4 handles.



# CAM & GROOVE COUPLINGS

## DUST CAP

▶ All Couplers Supplied with Buna-N Gaskets

– NOT DESIGNED FOR PRESSURE APPLICATIONS –



| Size   | ALUMINUM       |      | BRASS        |      | 316 SS   |      | 304 SS      |      |
|--------|----------------|------|--------------|------|----------|------|-------------|------|
|        | Part #         | List | Part #       | List | Part #   | List | Part #      | List |
| 1/2"   | DC 050IAL      |      | DC 050IBR    |      | DC 050SS |      | DC 050SS304 |      |
| 3/4"   | DC 075IAL      |      | DC 075IBR    |      | DC 075SS |      | DC 075SS304 |      |
| 1"     | DC 100IAL      |      | DC 100IBR    |      | DC 100SS |      | DC 100SS304 |      |
| 1-1/4" | DC 125IAL      |      | DC 125IBR    |      | DC 125SS |      | DC 125SS304 |      |
| 1-1/2" | DC 150IAL      |      | DC 150IBR    |      | DC 150SS |      | DC 150SS304 |      |
| 2"     | DC 200IAL      |      | DC 200IBR    |      | DC 200SS |      | DC 200SS304 |      |
| 2-1/2" | DC 250IAL      |      | DC 250IBR    |      | DC 250SS |      | DC 250SS304 |      |
| 3"     | DC 300IAL      |      | DC 300IBR    |      | DC 300SS |      | DC 300SS304 |      |
| 4"     | DC 400IAL      |      | DC 400IBR    |      | DC 400SS |      | DC 400SS304 |      |
| 5"     | DC 500ASTMAL   |      | DC 500ASTMBR |      | DC 500SS |      | DC 500SS304 |      |
| 6"     | DC 600IAL      |      | DC 600IBR    |      | DC 600SS |      | DC 600SS304 |      |
| 8"     | DC 800IALNAE*  |      | --           |      | --       |      | --          |      |
| 8"     | DC 800IALPTK** |      | --           |      | --       |      | --          |      |
| 10"    | DC 1000IAL     |      | --           |      | --       |      | --          |      |
| 12"    | DC 1200IAL     |      | --           |      | --       |      | --          |      |

\*NAE is "Large Body" - \*\*PTK is "Small Body"

## TYPE\*



| Size   | PLATED IRON |      | POLYPROPYLENE |      | NYGLASS       |      |
|--------|-------------|------|---------------|------|---------------|------|
|        | Part #      | List | Part #        | List | Part #        | List |
| 3/4"   | --          |      | DC 075PP      |      | DC 075NG      |      |
| 1"     | DC 100CI    |      | DC 100PP      |      | DC 100NG      |      |
| 1-1/4" | --          |      | DC 125125PP   |      | **DC 125125NG |      |
| 1-1/2" | DC 150CI    |      | DC 150PP      |      | **DC 150NG    |      |
| 2"     | DC 200CI    |      | DC 200PP      |      | DC 200NG      |      |
| 3"     | DC 300CI    |      | DC 300PP      |      | DC 300NG      |      |
| 4"     | DC 400CI    |      | DC 400PP      |      | DC 400NG      |      |
| 5"     | DC 500CI    |      | --            |      | --            |      |
| 6"     | DC 600CI    |      | --            |      | --            |      |

\*\* Available as: 1-1/4 adapter or coupler X 1-1/4 NPT | Please specify: 1-1/2 adapter or coupler X 1-1/4 NPT | 1-1/2 adapter or coupler X 1-1/2 NPT  
 Note: All Seal Fast Cam & Groove Stainless Bodies are 316 Investment with 304 Handles. \* Dust Caps and Dust Plugs are not designed for pressure applications.



# CAM & GROOVE COUPLINGS

## DUST PLUG

– NOT DESIGNED FOR PRESSURE APPLICATIONS –



COUPLINGS +



| Size   | ALUMINUM       |      | BRASS        |      | 316 SS   |      | 304 SS      |      |
|--------|----------------|------|--------------|------|----------|------|-------------|------|
|        | Part #         | List | Part #       | List | Part #   | List | Part #      | List |
| 1/2"   | DP 050IAL      |      | DP 050IBR    |      | DP 050SS |      | DP 050SS304 |      |
| 3/4"   | DP 075IAL      |      | DP 075IBR    |      | DP 075SS |      | DP 075SS304 |      |
| 1"     | DP 100IAL      |      | DP 100IBR    |      | DP 100SS |      | DP 100SS304 |      |
| 1-1/4" | DP 125IAL      |      | DP 125IBR    |      | DP 125SS |      | DP 125SS304 |      |
| 1-1/2" | DP 150IAL      |      | DP 150IBR    |      | DP 150SS |      | DP 150SS304 |      |
| 2"     | DP 200IAL      |      | DP 200IBR    |      | DP 200SS |      | DP 200SS304 |      |
| 2-1/2" | DP 250IAL      |      | DP 250IBR    |      | DP 250SS |      | DP 250SS304 |      |
| 3"     | DP 300IAL      |      | DP 300IBR    |      | DP 300SS |      | DP 300SS304 |      |
| 4"     | DP 400IAL      |      | DP 400IBR    |      | DP 400SS |      | DP 400SS304 |      |
| 5"     | DP 500ASTMAL   |      | DP 500ASTMBR |      | DP 500SS |      | DP 500SS304 |      |
| 6"     | DP 600IAL      |      | DP 600IBR    |      | DP 600SS |      | DP 600SS304 |      |
| 8"     | DP 800IALNAE*  |      | --           |      | --       |      | --          |      |
| 8"     | DP 800IALPTK** |      | --           |      | --       |      | --          |      |
| 10"    | DP 1000IAL     |      | --           |      | --       |      | --          |      |
| 12"    | DP 1200IAL     |      | --           |      | --       |      | --          |      |

\*NAE is "Large Body" - \*\*PTK is "Small Body"

TYPE\*  
**DP**



| Size   | PLATED IRON |      | POLYPROPYLENE |      | NYGLASS    |      |
|--------|-------------|------|---------------|------|------------|------|
|        | Part #      | List | Part #        | List | Part #     | List |
| 3/4"   | ---         |      | DP 075PP      |      | DP 075NG   |      |
| 1"     | DP 100CI    |      | DP 100PP      |      | DP 100NG   |      |
| 1-1/4" | ---         |      | DP 125125PP   |      | **DP 125NG |      |
| 1-1/2" | DP 150CI    |      | DP 150PP      |      | **DP 150NG |      |
| 2"     | DP 200CI    |      | DP 200PP      |      | DP 200NG   |      |
| 3"     | DP 300CI    |      | DP 300PP      |      | DP 300NG   |      |
| 4"     | DP 400CI    |      | DP 400PP      |      | DP 400NG   |      |
| 5"     | DP 500CI    |      | ---           |      | ---        |      |
| 6"     | DP 600CI    |      | ---           |      | ---        |      |

\*\* Available as: 1-1/4 adapter or coupler X 1-1/4 NPT | Please specify: 1-1/2 adapter or coupler X 1-1/4 NPT | 1-1/2 adapter or coupler X 1-1/2 NPT  
\* Dust Caps and Dust Plugs are not designed for pressure applications.



# CAM & GROOVE COUPLINGS

## FEMALE NPT X MALE ADAPTER



TYPE A

| Size   | 356 T6 ALUMINUM |      | BANJO - POLYPROPYLENE |      |
|--------|-----------------|------|-----------------------|------|
|        | Part #          | List | Part #                | List |
| 1/2"   | ---             |      | 050APP                |      |
| 3/4"   | A 075AL         |      | 075APP                |      |
| 1"     | A 100AL         |      | 100APP                |      |
| 1-1/4" | A 125AL         |      | *125APP               |      |
| 1-1/2" | A 150AL         |      | 150APP                |      |
| 2"     | A 200AL         |      | 200APP                |      |
| 2-1/2" | A 250AL         |      | ---                   |      |
| 3"     | A 300AL         |      | 300APP                |      |
| 4"     | A 400AL         |      | 400APP                |      |
| 5"     | A 500AL         |      | ---                   |      |
| 6"     | A 600AL         |      | ---                   |      |

# PREMIUM

## FEMALE COUPLER X MALE NPT



TYPE B

| Size   | 356 T6 ALUMINUM |      | BANJO - POLYPROPYLENE |      |
|--------|-----------------|------|-----------------------|------|
|        | Part #          | List | Part #                | List |
| 1/2"   | ---             |      | 050B PP               |      |
| 3/4"   | B 075AL         |      | 075B PP               |      |
| 1"     | B 100AL         |      | 100B PP               |      |
| 1-1/4" | B 125AL         |      | *125B PP              |      |
| 1-1/2" | B 150AL         |      | 150B PP               |      |
| 2"     | B 200AL         |      | 200B PP               |      |
| 2-1/2" | B 250AL         |      | ---                   |      |
| 3"     | B 300AL         |      | 300B PP               |      |
| 4"     | B 400AL         |      | 400B PP               |      |
| 5"     | B 500AL         |      | ---                   |      |
| 6"     | B 600AL         |      | ---                   |      |

## FEMALE COUPLER X SHANK



TYPE C

| Size   | 356 T6 ALUMINUM |      | BANJO - POLYPROPYLENE |      |
|--------|-----------------|------|-----------------------|------|
|        | Part #          | List | Part #                | List |
| 1/2"   | ---             |      | 050C PP               |      |
| 3/4"   | C 075AL         |      | 075C PP               |      |
| 1"     | C 100AL         |      | 100C PP               |      |
| 1-1/4" | C 125AL         |      | *125C PP              |      |
| 1-1/2" | C 150AL         |      | 150C PP               |      |
| 2"     | C 200AL         |      | 200C PP               |      |
| 2-1/2" | C 250AL         |      | ---                   |      |
| 3"     | C 300AL         |      | 300C PP               |      |
| 4"     | C 400AL         |      | 400C PP               |      |
| 5"     | C 500AL         |      | ---                   |      |
| 6"     | C 600AL         |      | ---                   |      |

## FEMALE COUPLER X FEMALE NPT



TYPE D

| Size   | 356 T6 ALUMINUM |      | BANJO - POLYPROPYLENE |      |
|--------|-----------------|------|-----------------------|------|
|        | Part #          | List | Part #                | List |
| 1/2"   | ---             |      | 050D PP               |      |
| 3/4"   | D 075AL         |      | 075D PP               |      |
| 1"     | D 100AL         |      | 100D PP               |      |
| 1-1/4" | D 125AL         |      | *125D PP              |      |
| 1-1/2" | D 150AL         |      | 150D PP               |      |
| 2"     | D 200AL         |      | 200D PP               |      |
| 2-1/2" | D 250AL         |      | ---                   |      |
| 3"     | D 300AL         |      | 300D PP               |      |
| 4"     | D 400AL         |      | 400D PP               |      |
| 5"     | D 500AL         |      | ---                   |      |
| 6"     | D 600AL         |      | ---                   |      |

\*Banjo Poly 1-1/4" X 1"



# PREMIUM

# CAM & GROOVE COUPLINGS

## MALE ADAPTER X SHANK



TYPE  
**E**

| Size   | 356 T6 ALUMINUM |      | BANJO - POLYPROPYLENE |      |
|--------|-----------------|------|-----------------------|------|
|        | Part #          | List | Part #                | List |
| 1/2"   | ----            |      | 050E PP               |      |
| 3/4"   | E 075AL         |      | 075E PP               |      |
| 1"     | E 100AL         |      | 100E PP               |      |
| 1-1/4" | E 125AL         |      | *125E PP              |      |
| 1-1/2" | E 150AL         |      | 150E PP               |      |
| 2"     | E 200AL         |      | 200E PP               |      |
| 2-1/2" | E 250AL         |      | ---                   |      |
| 3"     | E 300AL         |      | 300E PP               |      |
| 4"     | E 400AL         |      | 400E PP               |      |
| 5"     | E 500AL         |      | ---                   |      |
| 6"     | E 600AL         |      | ---                   |      |

## MALE ADAPTER X MALE NPT



TYPE  
**F**

| Size   | 356 T6 ALUMINUM |      | BANJO - POLYPROPYLENE |      |
|--------|-----------------|------|-----------------------|------|
|        | Part #          | List | Part #                | List |
| 1/2"   | ----            |      | 050F PP               |      |
| 3/4"   | F 075AL         |      | 075F PP               |      |
| 1"     | F 100AL         |      | 100F PP               |      |
| 1-1/4" | F 125AL         |      | *125F PP              |      |
| 1-1/2" | F 150AL         |      | 150F PP               |      |
| 2"     | F 200AL         |      | 200F PP               |      |
| 2-1/2" | F 250AL         |      | ---                   |      |
| 3"     | F 300AL         |      | 300F PP               |      |
| 4"     | F 400AL         |      | 400F PP               |      |
| 5"     | F 500AL         |      | ---                   |      |
| 6"     | F 600AL         |      | ---                   |      |

COUPLINGS +



## DUST CAP

– NOT DESIGNED FOR PRESSURE APPLICATIONS –



TYPE  
**\*DC**

| Size   | 356 T6 ALUMINUM |      | BANJO - POLYPROPYLENE |      |
|--------|-----------------|------|-----------------------|------|
|        | Part #          | List | Part #                | List |
| 3/4"   | DC 075AL        |      | 075DC PP              |      |
| 1"     | DC 100AL        |      | 100DC PP              |      |
| 1-1/4" | DC 125AL        |      | *125DC PP             |      |
| 1-1/2" | DC 150AL        |      | 150DC PP              |      |
| 2"     | DC 200AL        |      | 200DC PP              |      |
| 2-1/2" | DC 250AL        |      | ---                   |      |
| 3"     | DC 300AL        |      | 300DC PP              |      |
| 4"     | DC 400AL        |      | 400DC PP              |      |
| 5"     | DC 500AL        |      | ---                   |      |
| 6"     | DC 600AL        |      | ---                   |      |

## DUST PLUG



TYPE  
**\*DP**

| Size   | 356 T6 ALUMINUM |      | BANJO - POLYPROPYLENE |      |
|--------|-----------------|------|-----------------------|------|
|        | Part #          | List | Part #                | List |
| 3/4"   | DP 075AL        |      | 075DP PP              |      |
| 1"     | DP 100AL        |      | 100DP PP              |      |
| 1-1/4" | DP 125AL        |      | *125DP PP             |      |
| 1-1/2" | DP 150AL        |      | 150DP PP              |      |
| 2"     | DP 200AL        |      | 200DP PP              |      |
| 2-1/2" | DP 250AL        |      | ---                   |      |
| 3"     | DP 300AL        |      | 300DP PP              |      |
| 4"     | DP 400AL        |      | 400DP PP              |      |
| 5"     | DP 500AL        |      | ---                   |      |
| 6"     | DP 600AL        |      | ---                   |      |

\* Dust Caps and Dust Plugs are not designed for pressure applications. | \*\*Banjo Poly 1-1/4" X 1"



# CAM & GROOVE COUPLINGS



COUPLINGS +



## FEMALE COUPLER X SHANK

▶\*Aluminum & Brass have Machined Shanks



**TYPE C**

| Size   | ALUMINUM |      | BRASS    |      | 316 SS   |      |
|--------|----------|------|----------|------|----------|------|
|        | Part #   | List | Part #   | List | Part #   | List |
| 1"     | C 100ALC |      | C 100BRC |      | C 100SSC |      |
| 1-1/2" | C 150ALC |      | C 150BRC |      | C 150SSC |      |
| 2"     | C 200ALC |      | C 200BRC |      | C 200SSC |      |
| 2-1/2" | C 250ALC |      | C 250BRC |      | C 250SSC |      |
| 3"     | C 300ALC |      | C 300BRC |      | C 300SSC |      |
| 4"     | C 400ALC |      | C 400BRC |      | C 400SSC |      |
| 6"     | C 600ALC |      | C 600BRC |      | C 600SSC |      |

## MALE COUPLER X SHANK



**TYPE E**

| Size   | ALUMINUM |      | BRASS    |      | 316 SS   |      |
|--------|----------|------|----------|------|----------|------|
|        | Part #   | List | Part #   | List | Part #   | List |
| 1"     | E 100ALC |      | E 100BRC |      | E 100SSC |      |
| 1-1/2" | E 150ALC |      | E 150BRC |      | E 150SSC |      |
| 2"     | E 200ALC |      | E 200BRC |      | E 200SSC |      |
| 2-1/2" | E 250ALC |      | E 250BRC |      | E 250SSC |      |
| 3"     | E 300ALC |      | E 300BRC |      | E 300SSC |      |
| 4"     | E 400ALC |      | E 400BRC |      | E 400SSC |      |
| 6"     | E 600ALC |      | E 600BRC |      | E 600SSC |      |

Seal Fast Crimp Cam and Groove couplings are to be used with the Seal Fast Ferrules and Crimps Sleeves on pages 68-71 of this catalog. They are designed with an Interlock System which allows the Ferrule to be permanently attached to the coupling

## FEMALE COUPLER X SHANK

## MALE ADAPTER X SHANK



| PLATED IRON |      |
|-------------|------|
| Part #      | List |
| ---         |      |
| ---         |      |
| ---         |      |
| C 300CIC    |      |
| C 400CIC    |      |
| ---         |      |
| ---         |      |



TYPE **CL**

| Size   | 316 SS    |      |
|--------|-----------|------|
|        | Part #    | List |
| 1-1/2" | CL 150 SS |      |
| 2"     | CL 200 SS |      |
| 3"     | CL 300 SS |      |
| 4"     | CL 400 SS |      |

\*Couplings used with Notched Ferrule on [p.186](#)



| PLATED IRON |      |
|-------------|------|
| Part #      | List |
| ---         |      |
| ---         |      |
| ---         |      |
| E 300CIC    |      |
| E 400CIC    |      |
| ---         |      |
| ---         |      |



TYPE **EL**

| Size   | 316 SS   |      |
|--------|----------|------|
|        | Part #   | List |
| 1-1/2" | EL 150SS |      |
| 2"     | EL 200SS |      |
| 3"     | EL 300SS |      |
| 4"     | EL 400SS |      |

\*Couplings used with Notched Ferrule on [p.186](#)



# CAM & GROOVE COUPLINGS

# SELF LOCKING

COUPLINGS +



## FEMALE COUPLER X MALE NPT

TYPE **B**



| Size   | ALUMINUM  |      | BRASS     |      | 316 SS   |      |
|--------|-----------|------|-----------|------|----------|------|
|        | Part #    | List | Part #    | List | Part #   | List |
| 1"     | B 100ALSK |      | B 100BRSK |      | B 100SSK |      |
| 1-1/2" | B 150ALSK |      | B 150BRSK |      | B 150SSK |      |
| 2"     | B 200ALSK |      | B 200BRSK |      | B 200SSK |      |
| 2-1/2" | B 250ALSK |      | B 250BRSK |      | B 250SSK |      |
| 3"     | B 300ALSK |      | B 300BRSK |      | B 300SSK |      |
| 4"     | B 400ALSK |      | B 400BRSK |      | B 400SSK |      |

## FEMALE COUPLER X HOSE SHANK

TYPE **C**



| Size   | ALUMINUM  |      | BRASS     |      | 316 SS   |      |
|--------|-----------|------|-----------|------|----------|------|
|        | Part #    | List | Part #    | List | Part #   | List |
| 1"     | C 100ALSK |      | C 100BRSK |      | C 100SSK |      |
| 1-1/2" | C 150ALSK |      | C 150BRSK |      | C 150SSK |      |
| 2"     | C 200ALSK |      | C 200BRSK |      | C 200SSK |      |
| 2-1/2" | C 250ALSK |      | C 250BRSK |      | C 250SSK |      |
| 3"     | C 300ALSK |      | C 300BRSK |      | C 300SSK |      |
| 4"     | C 400ALSK |      | C 400BRSK |      | C 400SSK |      |

## FEMALE COUPLER X MALE ADAPTER

w/PIPE TAP

TYPE **DA**



w/ 1/2" Pipe Tap

| Size    | 316 SS     |      |
|---------|------------|------|
|         | Part #     | List |
| 3" X 2" | DA 3020SSK |      |

| Size    | 316 SS       |      |
|---------|--------------|------|
|         | Part #       | List |
| 3" X 2" | DA 3020-1SSK |      |

# SELF LOCKING

# CAM & GROOVE COUPLINGS

## FEMALE COUPLER X FEMALE NPT

TYPE **D**



| Size   | ALUMINUM  |      | BRASS     |      | 316 SS   |      |
|--------|-----------|------|-----------|------|----------|------|
|        | Part #    | List | Part #    | List | Part #   | List |
| 1"     | D 100ALSK |      | D 100BRSK |      | D 100SSK |      |
| 1-1/2" | D 150ALSK |      | D 150BRSK |      | D 150SSK |      |
| 2"     | D 200ALSK |      | D 200BRSK |      | D 200SSK |      |
| 2-1/2" | D 250ALSK |      | D 250BRSK |      | D 250SSK |      |
| 3"     | D 300ALSK |      | D 300BRSK |      | D 300SSK |      |
| 4"     | D 400ALSK |      | D 400BRSK |      | D 400SSK |      |

COUPLINGS +



## DUST CAP COUPLER

– NOT DESIGNED FOR PRESSURE APPLICATIONS –

TYPE **DC**



| Size   | ALUMINUM   |      | BRASS      |      | 316 SS    |      |
|--------|------------|------|------------|------|-----------|------|
|        | Part #     | List | Part #     | List | Part #    | List |
| 1"     | DC 100ALSK |      | DC 100BRSK |      | DC 100SSK |      |
| 1-1/2" | DC 150ALSK |      | DC 150BRSK |      | DC 150SSK |      |
| 2"     | DC 200ALSK |      | DC 200BRSK |      | DC 200SSK |      |
| 2-1/2" | DC 250ALSK |      | DC 250BRSK |      | DC 250SSK |      |
| 3"     | DC 300ALSK |      | DC 300BRSK |      | DC 300SSK |      |
| 4"     | DC 400ALSK |      | DC 400BRSK |      | DC 400SSK |      |

## FEMALE COUPLER X FEMALE COUPLER

TYPE **DD**



| Size | 316 SS    |      |
|------|-----------|------|
|      | Part #    | List |
| 2"   | DD 200SSK |      |
| 3"   | DD 300SSK |      |

\* Dust Caps and Dust Plugs are not designed for pressure applications.  
\* With auto-lock handles



# CAM & GROOVE COUPLINGS

# ELBOW

## 90° - MALE ADAPTER X FEMALE NPT

## 90° - FEMALE COUPLER X MALE NPT



| Size   | ALUMINUM |      | POLYPROPYLENE |      |
|--------|----------|------|---------------|------|
|        | Part #   | List | Part #        | List |
| 1-1/2" | A150AL90 |      | A15090PP      |      |
| 2"     | A200AL90 |      | A20090PP      |      |
| 3"     | A300AL90 |      |               |      |
| 4"     | A400AL90 |      |               |      |



| Size   | ALUMINUM |      | POLYPROPYLENE |      |
|--------|----------|------|---------------|------|
|        | Part #   | List | Part #        | List |
| 1-1/2" | B150AL90 |      | B15090PP      |      |
| 2"     | B200AL90 |      | B20090PP      |      |

## 90° - FEMALE COUPLER X SHANK

## 90° - FEMALE COUPLER X FEMALE NPT



| Size   | ALUMINUM |      | POLYPROPYLENE |      |
|--------|----------|------|---------------|------|
|        | Part #   | List | Part #        | List |
| 1"     | ---      |      | C10090PP      |      |
| 1-1/2" | C150AL90 |      | C15090PP      |      |
| 2"     | C200AL90 |      | C20090PP      |      |
| 3"     | C300AL90 |      | C30090PP      |      |
| 4"     | C400AL90 |      | ---           |      |
| 6"     | C600AL90 |      | ---           |      |



| Size   | ALUMINUM |      | POLYPROPYLENE |      |
|--------|----------|------|---------------|------|
|        | Part #   | List | Part #        | List |
| 1-1/2" | D150AL90 |      | D15090PP      |      |
| 2"     | D200AL90 |      | D20090PP      |      |
| 3"     | D300AL90 |      |               |      |
| 4"     | D400AL90 |      |               |      |
| 6"     | D600AL90 |      |               |      |

## 90° - MALE ADAPTER X SHANK

## 90° - MALE ADAPTER X MALE NPT



| Size   | ALUMINUM |      | POLYPROPYLENE |      |
|--------|----------|------|---------------|------|
|        | Part #   | List | Part #        | List |
| 1-1/2" | ---      |      | E15090PP      |      |
| 2"     | ---      |      | E20090PP      |      |
| 3"     | E300AL90 |      | ---           |      |
| 4"     | E400AL90 |      | ---           |      |



| Size   | ALUMINUM |      | POLYPROPYLENE |      |
|--------|----------|------|---------------|------|
|        | Part #   | List | Part #        | List |
| 1-1/2" | F150AL90 |      | F15090PP      |      |
| 2"     | F200AL90 |      | F20090PP      |      |
| 3"     | ---      |      | ---           |      |
| 4"     | ---      |      | ---           |      |

COUPLINGS +



TYPE 90°

TYPE 90°

TYPE 90°

TYPE 90°

TYPE 90°

TYPE 90°

# ELBOW

# CAM & GROOVE COUPLINGS

90° - FEMALE COUPLER X MALE ADAPTOR 45° - FEMALE COUPLER X MALE ADAPTOR

COUPLINGS +



TYPE 90°  
**DA**



TYPE 45°  
**DA**



| Size    | ALUMINUM   |      |
|---------|------------|------|
|         | Part #     | List |
| 1.5"    | DA150AL90  |      |
| 2"      | DA200AL90  |      |
| 2" X 3" | DA2030AL90 |      |
| 3"      | DA300AL90  |      |
| 3" X 2" | DA3020AL90 |      |
| 3" X 4" | DA3040AL90 |      |
| 4"      | DA400AL90  |      |
| 4" X 3" | DA4030AL90 |      |
| 6"      | DA600AL90  |      |

| ALUMINUM  |      | PLATED IRON |      |
|-----------|------|-------------|------|
| Part #    | List | Part #      | List |
| ---       |      | ---         |      |
| DA200AL45 |      | DA200CI45   |      |
| DA300AL45 |      | DA300CI45   |      |
| DA400AL45 |      | DA400CI45   |      |
| DA600AL45 |      |             |      |

90° - FEMALE COUPLER X FEMALE COUPLER



TYPE 90°  
**DD**

| Size | ALUMINUM  |      |
|------|-----------|------|
|      | Part #    | List |
| 2"   | DD200AL90 |      |
| 3"   | DD300AL90 |      |
| 4"   | DD400AL90 |      |
| 6"   | DD600AL90 |      |



# CAM & GROOVE COUPLINGS

## FEMALE BSPT X MALE ADAPTER



TYPE  
**A**

| Size   | ALUMINUM    |      | 316 SS     |      |
|--------|-------------|------|------------|------|
|        | Part #      | List | Part #     | List |
| 1-1/2" | A 150IALBSP |      | A 150SSBSP |      |
| 2"     | A 200IALBSP |      | A 200SSBSP |      |
| 3"     | A 300IALBSP |      | A 300SSBSP |      |
| 4"     | A 400IALBSP |      | A 400SSBSP |      |
| 6"     | A 600IALBSP |      | ---        |      |

# BSPT

## FEMALE COUPLER X MALE BSPT



TYPE  
**B**

| Size   | ALUMINUM    |      | 316 SS     |      |
|--------|-------------|------|------------|------|
|        | Part #      | List | Part #     | List |
| 1-1/2" | B 150IALBSP |      | B 150SSBSP |      |
| 2"     | B 200IALBSP |      | B 200SSBSP |      |
| 3"     | B 300IALBSP |      | B 300SSBSP |      |
| 4"     | B 400IALBSP |      | B 400SSBSP |      |
| 6"     | B 600IALBSP |      | ---        |      |

## FEMALE COUPLER X FEMALE BSPT



TYPE  
**D**

| Size   | ALUMINUM    |      | 316 SS     |      |
|--------|-------------|------|------------|------|
|        | Part #      | List | Part #     | List |
| 1-1/2" | D 150IALBSP |      | D 150SSBSP |      |
| 2"     | D 200IALBSP |      | D 200SSBSP |      |
| 3"     | D 300IALBSP |      | D 300SSBSP |      |
| 4"     | D 400IALBSP |      | D 400SSBSP |      |
| 6"     | D 600IALBSP |      | ---        |      |

## MALE ADAPTER X MALE BSPT



TYPE  
**F**

| Size   | ALUMINUM    |      | 316 SS     |      |
|--------|-------------|------|------------|------|
|        | Part #      | List | Part #     | List |
| 1-1/2" | F 150IALBSP |      | F 150SSBSP |      |
| 2"     | F 200IALBSP |      | F 200SSBSP |      |
| 3"     | F 300IALBSP |      | F 300SSBSP |      |
| 4"     | F 400IALBSP |      | F 400SSBSP |      |
| 6"     | F 600IALBSP |      | ---        |      |



# SPECIALTY

# CAM & GROOVE COUPLINGS

## SOCKET WELD X ADAPTER

## SOCKET WELD X COUPLER

COUPLINGS +



| Size   | ALUMINUM |        |      | 316 SS    |        |      |
|--------|----------|--------|------|-----------|--------|------|
|        | Part #   | Bore   | List | Part #    | Bore   | List |
| 1-1/2" | AW 150AL | 1.915" |      | AW 150SSI | 1.915" |      |
| 2"     | AW 200AL | 2.390" |      | AW 200SSI | 2.390" |      |
| 3"     | AW 300AL | 3.530" |      | AW 300SSI | 3.530" |      |
| 4"     | AW 400AL | 4.530" |      | AW 400SSI | 4.530" |      |
| 6"     | AW 600AL | 4.530" |      | AW 600SSI | 4.530" |      |

| Size   | ALUMINUM |        |      | 316 SS    |        |      |
|--------|----------|--------|------|-----------|--------|------|
|        | Part #   | Bore   | List | Part #    | Bore   | List |
| 1-1/2" | DW 150AL | 1.915" |      | DW 150SSI | 1.915" |      |
| 2"     | DW 200AL | 2.390" |      | DW 200SSI | 2.390" |      |
| 3"     | DW 300AL | 3.530" |      | DW 300SSI | 3.530" |      |
| 4"     | DW 400AL | 4.530" |      | DW 400SSI | 4.530" |      |
| 6"     | DW 600AL | 4.530" |      | DW 600SSI | 4.530" |      |

Aluminum Coming Soon

Aluminum Coming Soon

## FLANGED ADAPTER - 150 #

## FLANGED COUPLER - 150 #



\*PTK is "Small Body"

\*PTK is "Small Body"

| Size   | ALUMINUM     |      | 316 SS   |      |
|--------|--------------|------|----------|------|
|        | Part #       | List | Part #   | List |
| 1"     | ---          | ---  | FA 100SS |      |
| 1-1/2" | ---          | ---  | FA 150SS |      |
| 2"     | FA 200AL     |      | FA 200SS |      |
| 3"     | FA 300AL     |      | FA 300SS |      |
| 4"     | FA 400AL     |      | FA 400SS |      |
| 6"     | FA 600AL     |      | FA 600SS |      |
| 8"     | *FA 800ALPTK |      | ---      | ---  |

| Size   | ALUMINUM     |      | 316 SS   |      |
|--------|--------------|------|----------|------|
|        | Part #       | List | Part #   | List |
| 1"     | ---          | ---  | FC 100SS |      |
| 1-1/2" | ---          | ---  | FC 150SS |      |
| 2"     | FC 200AL     |      | FC 200SS |      |
| 3"     | FC 300AL     |      | FC 300SS |      |
| 4"     | FC 400AL     |      | FC 400SS |      |
| 6"     | FC 600AL     |      | FC 600SS |      |
| 8"     | *FC 800ALPTK |      | ---      | ---  |

## LOCKABLE DUST CAP - NOT DESIGNED FOR PRESSURE APPLICATIONS -

## REPLACEMENT HANDLE



| Size   | ALUMINUM   |      | BRASS      |      | 316 SS    |      |
|--------|------------|------|------------|------|-----------|------|
|        | Part #     | List | Part #     | List | Part #    | List |
| 1-1/2" | DCL 150IAL |      | ---        |      | DCL 150SS |      |
| 2"     | DCL 200IAL |      | DCL 200IBR |      | DCL 200SS |      |
| 3"     | DCL 300IAL |      | DCL 300IBR |      | DCL 300SS |      |
| 4"     | DCL 400IAL |      | DCL 400IBR |      | DCL 400SS |      |
| 6"     | DCL 600IAL |      | ---        |      | ---       |      |

| 316 SS   |      |
|----------|------|
| Part #   | List |
| ---      |      |
| LH 200SS |      |
| LH 300SS |      |
| LH 400SS |      |
| LH 600SS |      |



# CAM & GROOVE COUPLINGS

# SPECIALTY

COUPLINGS +

## SPOOL ADAPTERS - MALE ADAPTER X MALE ADAPTER

w/PIPE TAP



| Size        | ALUMINUM  |      | BRASS    |      | 316 SS    |      |
|-------------|-----------|------|----------|------|-----------|------|
|             | Part #    | List | Part #   | List | Part #    | List |
| 3/4"        | ---       |      | ---      |      | SA 075SS  |      |
| 1"          | SA 100AL  |      | SA 100BR |      | SA 100SS  |      |
| 1-1/4"      | SA 125AL  |      | SA 125BR |      | SA 125SS  |      |
| 1-1/2"      | SA 150AL  |      | SA 150BR |      | SA 150SS  |      |
| 1-1/2" X 2" | SA 1520AL |      | ---      |      | SA 1520SS |      |
| 2"          | SA 200AL  |      | SA 200BR |      | SA 200SS  |      |
| 2" X 2-1/2" | SA 2025AL |      | ---      |      | SA 2025SS |      |
| 2" x 3"     | SA 2030AL |      | ---      |      | SA 2030SS |      |
| 2" x 4"     | SA 2040AL |      | ---      |      | ---       |      |
| 2-1/2"      | SA 250AL  |      | SA 250BR |      | SA 250SS  |      |
| 3"          | SA 300AL  |      | SA 300BR |      | SA 300SS  |      |
| 3" X 4"     | SA 3040AL |      | ---      |      | SA 3040SS |      |
| 4"          | SA 400AL  |      | SA 400BR |      | SA 400SS  |      |
| 4" X 1-1/2" | SA 4015AL |      | ---      |      | ---       |      |
| 4" X 2"     | SA 4020AL |      | ---      |      | ---       |      |
| 4" X 5"     | SA 4050AL |      | ---      |      | ---       |      |
| 4" X 6"     | SA 4060AL |      | ---      |      | SA 4060SS |      |
| 5"          | SA 500AL  |      | ---      |      | ---       |      |
| 6"          | SA 600AL  |      | ---      |      | SA 600SS  |      |

| Size               | 316 SS     |      |
|--------------------|------------|------|
|                    | Part #     | List |
| 2" X 2" X 1/2" NPT | SA 200-1SS |      |
| 2" X 2" X 3/4" NPT | SA 200-2SS |      |
| 3" X 3" X 1/2" NPT | SA 300-1SS |      |
| 3" X 3" X 3/4" NPT | SA 300-2SS |      |
| 3" X 3" X 1" NPT   | SA 300-3SS |      |

## SPOOL COUPLERS - FEMALE COUPLER X FEMALE COUPLER

w/PIPE TAP



| Size        | ALUMINUM  |      | BRASS    |      | 316 SS    |      |
|-------------|-----------|------|----------|------|-----------|------|
|             | Part #    | List | Part #   | List | Part #    | List |
| 1-1/2"      | DD 150AL  |      | ---      |      | DD 150SS  |      |
| 2"          | DD 200AL  |      | ---      |      | DD 200SS  |      |
| 2" X 3"     | DD 2030AL |      | ---      |      | ---       |      |
| 2-1/2"      | ---       |      | ---      |      | DD 250SS  |      |
| 3"          | DD 300AL  |      | ---      |      | DD 300SS  |      |
| 3" X 2"     | DD 3020AL |      | ---      |      | DD 3020SS |      |
| 3" X 2-1/2" | DD 3025AL |      | ---      |      | ---       |      |
| 3" X 4"     | DD 3040AL |      | ---      |      | DD 3040SS |      |
| 4"          | DD 400AL  |      | DD 400BR |      | DD 400SS  |      |
| 4-1/2"      | DD 4015AL |      | ---      |      | ---       |      |
| 5" X 4"     | ---       |      | ---      |      | DD 5040SS |      |
| 6"          | DD 600AL  |      | ---      |      | ---       |      |

| Size               | 316 SS     |      |
|--------------------|------------|------|
|                    | Part #     | List |
| 2" X 2" X 1/2" NPT | DD 200-1SS |      |
| 2" X 2" X 3/4" NPT | DD 200-2SS |      |
| 3" X 3" X 1/2" NPT | DD 300-1SS |      |
| 3" X 3" X 3/4" NPT | DD 300-2SS |      |

# SPECIALTY

# CAM & GROOVE COUPLINGS

## REDUCING DA - FEMALE COUPLER X MALE ADAPTER

w/PIPE TAP

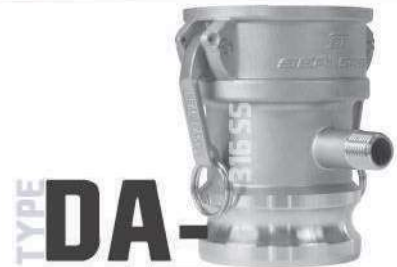

| Size        | ALUMINUM      |      | BRASS     |      | 316 SS    |      |
|-------------|---------------|------|-----------|------|-----------|------|
|             | Part #        | List | Part #    | List | Part #    | List |
| 1-1/2" x 1" | DA 1510AL     | ---  | ---       | ---  | DA 1510SS | ---  |
| 1-1/2" x 2" | DA 1520AL     | ---  | ---       | ---  | DA 1520SS | ---  |
| 2" x 1"     | ---           | ---  | ---       | ---  | DA 2010SS | ---  |
| 2" x 1-1/2" | DA 2015AL     | ---  | ---       | ---  | DA 2015SS | ---  |
| 2" x 2"     | ---           | ---  | ---       | ---  | DA 2020SS | ---  |
| 2" x 3"     | DA 2030AL     | ---  | DA 2030BR | ---  | DA 2030SS | ---  |
| 2" x 4"     | DA 2040AL     | ---  | ---       | ---  | DA 2040SS | ---  |
| 2-1/2" x 2" | ---           | ---  | ---       | ---  | DA 2520SS | ---  |
| 3" x 1-1/2" | DA 3015AL     | ---  | ---       | ---  | DA 3015SS | ---  |
| 3" x 2"     | DA 3020AL     | ---  | DA 3020BR | ---  | DA 3020SS | ---  |
| 3" x 2-1/2" | DA 3025AL     | ---  | ---       | ---  | ---       | ---  |
| 3" x 3"     | ---           | ---  | ---       | ---  | DA 3030SS | ---  |
| 3" x 4"     | DA 3040AL     | ---  | DA 3040BR | ---  | DA 3040SS | ---  |
| 3" x 6"     | DA 3060AL     | ---  | ---       | ---  | ---       | ---  |
| 4" x 1-1/2" | DA 4015AL     | ---  | ---       | ---  | ---       | ---  |
| 4" x 2"     | DA 4020AL     | ---  | DA 4020BR | ---  | DA 4020SS | ---  |
| 4" x 2.5"   | ---           | ---  | ---       | ---  | DA 4025SS | ---  |
| 4" x 3"     | DA 4030AL     | ---  | DA 4030BR | ---  | DA 4030SS | ---  |
| 4" x 5"     | DA 4050AL     | ---  | ---       | ---  | ---       | ---  |
| 4" x 6"     | DA 4060AL     | ---  | ---       | ---  | DA 4060SS | ---  |
| 5" x 4"     | DA 5040AL     | ---  | ---       | ---  | ---       | ---  |
| 6" x 3"     | DA 6030AL     | ---  | ---       | ---  | ---       | ---  |
| 6" x 4"     | DA 6040AL     | ---  | DA 6040BR | ---  | DA 6040SS | ---  |
| 6" x 5"     | DA 6050AL     | ---  | ---       | ---  | ---       | ---  |
| 8" x 6"     | *DA 8060ALPTK | ---  | ---       | ---  | ---       | ---  |

| Size               | 316 SS      |      |
|--------------------|-------------|------|
|                    | Part #      | List |
| 2" x 2" x 1/2" NPT | DA 2020-1SS | ---  |
| 2" x 2" x 1/2" NPT | DA 2020-2SS | ---  |
| 3" x 2" x 1/2" NPT | DA 3020-1SS | ---  |
| 3" x 2" x 3/4" NPT | DA 3020-2SS | ---  |
| 3" x 2" x 1" NPT   | DA 3020-3SS | ---  |
| 3" x 3" x 1/2" NPT | DA 3030-1SS | ---  |
| 3" x 4" x 1/2" NPT | DA 3040-1SS | ---  |
| 3" x 4" x 3/4" NPT | DA 3040-2SS | ---  |
| 4" x 3" x 1/2" NPT | DA 4030-1SS | ---  |
| 4" x 3" x 3/4" NPT | DA 4030-2SS | ---  |

COUPLINGS +



## REDUCING A - M X F NPT

## REDUCING BR - F X M NPT

## LONGNECK BLN - F X M NPT



## TYPE AR

## TYPE BR

## TYPE BLN

| Size        | ALUMINUM  |      |
|-------------|-----------|------|
|             | Part #    | List |
| 1-1/2" x 2" | AR 1520AL | ---  |
| 2" x 1-1/2" | AR 2015AL | ---  |
| 2" x 3"     | AR 2030AL | ---  |
| 3" x 2"     | AR 3020AL | ---  |
| 3" x 4"     | AR 3040AL | ---  |
| 4" x 3"     | AR 4030AL | ---  |
| 4" x 6"     | AR 4060AL | ---  |
| 6" x 4"     | AR 6040AL | ---  |

| Size        | ALUMINUM  |      |
|-------------|-----------|------|
|             | Part #    | List |
| 1-1/2" x 1" | BR 1510AL | ---  |
| 2" x 1-1/2" | BR 2015AL | ---  |
| 2" x 3"     | BR 2030AL | ---  |
| 3" x 2"     | BR 3020AL | ---  |
| 3" x 4"     | BR 3040AL | ---  |
| 4" x 3"     | BR 4030AL | ---  |
| 6" x 4"     | BR 6040AL | ---  |

| Size            | ALUMINUM       |      |
|-----------------|----------------|------|
|                 | Part #         | List |
| 1-1/2" x 1-1/2" | BLN 150AL      | ---  |
| 2" x 2"         | BLN 200AL      | ---  |
| 3" x 3"         | BLN 300AL      | ---  |
| 4" x 4"         | BLN 400AL      | ---  |
| 6" x 6"         | BLN 600AL      | ---  |
| 8" x 8"         | *BLN 800ALNAE  | ---  |
| 8" x 8"         | **BLN 800ALPTK | ---  |

| Size            | 316 SS    |      |
|-----------------|-----------|------|
|                 | Part #    | List |
| 1-1/2" x 1-1/2" | BLN 150SS | ---  |
| 2" x 2"         | BLN 200SS | ---  |
| 3" x 3"         | BLN 300SS | ---  |
| 4" x 4"         | BLN 400SS | ---  |
| 6" x 6"         | ---       | ---  |
| 8" x 8"         | ---       | ---  |

\*NAE is "Large Body" - \*\*PTK is "Small Body"

Brass Longneck BLN  
COMING SOON





# SPECIALTY

# CAM & GROOVE COUPLINGS

COUPLINGS +



## THREAD REDUCER FEMALE NPSM X MALE NPT



| Size                         | 316 SS |      |
|------------------------------|--------|------|
|                              | Part # | List |
| 3" Female NPSM X 2" Male NPT | 3020N  |      |
| PTFE 3" Gasket               | 300TG  |      |

## THREAD REDUCER - FEMALE BSPS X MALE NPT



| Size                          | ALUMINUM |      | 316 SS |      |
|-------------------------------|----------|------|--------|------|
|                               | Part #   | List | Part # | List |
| *3" Female BSPS X 2" Male NPT | 3020ALBN |      | 3020BN |      |
| *3" Female BSPS X 3" Male NPT | 3030ALBN |      | 3030BN |      |

\*Threads: BSP Straight

## THREAD INCREASER MALE NPT X FEMALE NPT X MALE NPT



| Size                           | ALUMINUM |      |
|--------------------------------|----------|------|
|                                | Part #   | List |
| 6" NPT-M X 5" NPT-F X 4" NPT-M | 6540AL   |      |
|                                | ---      |      |

## THREAD REDUCER - MALE NPT X FEMALE NPT



| Size                     | ALUMINUM |      | BRASS  |      |
|--------------------------|----------|------|--------|------|
|                          | Part #   | List | Part # | List |
| 3" NPT-M X 2" NPT-F      | 3020AL   |      | 3020BR |      |
| 4" NPT-M X 3" NPT-F      | 4030AL   |      | 4030BR |      |
| 6 -1/2" NPT-M X 4" NPT-F | 6540AL   |      | ---    |      |

## PIPE CAP



| Size                            | 316 SS      |      |
|---------------------------------|-------------|------|
|                                 | Part #      | List |
| 3" Female NPSM Pipe Cap         | PC 300SS    |      |
| 3" SS Cap w/BSP Straight Thread | PC 300SSBSP |      |
| PTFE 3" Gasket                  | 300TG       |      |
| Pipe Cap Hook                   | HC 300SS    |      |

## PIPE CAP - FUSIBLE



| Size                            | 316 SS    |      |
|---------------------------------|-----------|------|
|                                 | Part #    | List |
| 3" Female NPSM Fusible Pipe Cap | FPC 300SS |      |
|                                 | ---       |      |
|                                 | ---       |      |
|                                 | ---       |      |



# CAM & GROOVE COUPLINGS

## MALE ADAPTER X TTMA



| Size    | ALUMINUM    |      |
|---------|-------------|------|
|         | Part #      | List |
| 3"      | A300TTMAAL  |      |
| 3" x 4" | A3040TTMAAL |      |
| 4"      | A400TTMAAL  |      |
| 6"      | A600TTMAAL  |      |

# TTMA

## FEMALE COUPLER X TTMA



| Size | ALUMINUM   |      |
|------|------------|------|
|      | Part #     | List |
| 3"   | C300TTMAAL |      |
| 4"   | ---        |      |
| 6"   | C400TTMAAL |      |
|      | C600TTMAAL |      |

## FEMALE NPT X TTMA



| Size | ALUMINUM      |      |
|------|---------------|------|
|      | Part #        | List |
| 3"   | FNPT300TTMAAL |      |
| 4"   | FNPT400TTMAAL |      |
| 6"   | ---           |      |

## MALE NPT X TTMA



| Size | ALUMINUM      |      |
|------|---------------|------|
|      | Part #        | List |
| 3"   | MNPT300TTMAAL |      |
| 4"   | MNPT400TTMAAL |      |
| 6"   | MNPT600TTMAAL |      |



# GRAVITY DROP

# CAM & GROOVE COUPLINGS

## ADAPTER

► Available w/Self Locking Handles

### TYPE GA

- Attach directly against openable API's.
- Allows drop hose with standard Seal Fast cam and groove couplings to clamp on and transfer petroleum from the API valve.
- Meets API RP-1004 specifications.
- Heat treated aluminum alloy.
- With Stainless Steel self-locking handles.

| Size    | ALUMINUM w/SS Self Locking Handles |      |
|---------|------------------------------------|------|
|         | Part #                             | List |
| 4" X 3" | 1004GA-300                         |      |
| 4" X 4" | 1004GA-400                         |      |



- Attach directly against openable API's.
- Allows drop hose with standard Seal Fast cam and groove couplings to clamp on and transfer petroleum from the API valve.
- Meets API RP-1004 specifications.
- Heat treated aluminum alloy.
- With Brass handles.

| Size    | ALUMINUM w/Brass Handles |      |
|---------|--------------------------|------|
|         | Part #                   | List |
| 4" X 3" | 1004GA-300B              |      |
| 4" X 4" | 1004GA-400B              |      |



## COUPLER

► Available w/Self Locking Handles

### TYPE GB

- Attach directly against openable API's.
- Allows drop hose with standard Seal Fast cam and groove couplings to clamp on and transfer petroleum from the API valve.
- Meets API RP-1004 specifications.
- Heat treated aluminum alloy.
- With Stainless Steel self-locking handles.

| Size    | ALUMINUM   |      |
|---------|------------|------|
|         | Part #     | List |
| 4" X 3" | 1004GB-300 |      |
| 4" X 4" | 1004GB-400 |      |



| Size | GASKET - for Gravity Drop Couplings |      |
|------|-------------------------------------|------|
|      | Part #                              | List |
| 4"   | 1004GR                              |      |

COUPLINGS +





# CAM & GROOVE COUPLINGS

# HANDLES

COUPLINGS +



## REPLACEMENT HANDLE, RING & PIN KITS



## REPLACEMENT HANDLES



## REPLACEMENT RINGS & PINS



# HANDLES

# CAM & GROOVE COUPLINGS

## REPLACEMENT HANDLES

All Seal Fast cam arms are supplied complete with pins and spring steel finger rings. All brass, aluminum, and cast iron standard couplers and dust caps are supplied with brass or zinc alloy handles unless otherwise specified. Stainless and poly supplied with stainless steel handle  
 NOTE: Finger Rings are supplied on Cam Arms of Coupler Sizes 1-1/4" thru 5".



We also offer Plated Steel Pins & SS Rings. Please ask sales for item #.



| Size   | HANDLE, RING, PIN |      |           |      | HANDLE (only) |      |         |      | RING   |      | PIN     |      |
|--------|-------------------|------|-----------|------|---------------|------|---------|------|--------|------|---------|------|
|        | BRASS             |      | SS        |      | BRASS         |      | SS      |      | ZINC   |      | SS      |      |
|        | Part #            | List | Part #    | List | Part #        | List | Part #  | List | Part # | List | Part #  | List |
| 1/2"   | HRP 050BR         |      | HRP 050SS |      | H 050BR       |      | H 050SS |      | R 050  |      | P 050SS |      |
| 3/4"   | HRP 075BR         |      | HRP 075SS |      | H 075BR       |      | H 075SS |      | R 075  |      | P 075SS |      |
| 1"     | HRP 100BR         |      | HRP 100SS |      | H 100BR       |      | H 100SS |      | R 100  |      | P 100SS |      |
| 1-1/4" | HRP 200BR         |      | HRP 200SS |      | H 200BR       |      | H 200SS |      | R 200  |      | P 200SS |      |
| 1-1/2" | HRP 200BR         |      | HRP 200SS |      | H 200BR       |      | H 200SS |      | R 200  |      | P 200SS |      |
| 2"     | HRP 200BR         |      | HRP 200SS |      | H 200BR       |      | H 200SS |      | R 200  |      | P 200SS |      |
| 2-1/2" | HRP 200BR         |      | HRP 200SS |      | H 200BR       |      | H 200SS |      | R 200  |      | P 200SS |      |
| 3"     | HRP 300BR         |      | HRP 300SS |      | H 300BR       |      | H 300SS |      | R 300  |      | P 300SS |      |
| 4"     | HRP 300BR         |      | HRP 300SS |      | H 300BR       |      | H 300SS |      | R 300  |      | P 300SS |      |
| 5"     | HRP 300BR         |      | HRP 300SS |      | H 300BR       |      | H 300SS |      | R 300  |      | P 300SS |      |
| 6"     | HRP 600BR         |      | HRP 600SS |      | H 600BR       |      | H 600SS |      | R 600  |      | P 600SS |      |
| 8"     | --                |      | --        |      | H 800BR       |      | --      |      | --     |      | --      |      |



| Size | SELF LOCKING HANDLE |      |
|------|---------------------|------|
|      | SS                  |      |
|      | Part #              | List |
| 1"   | H 100SK             |      |
| 2"   | H 200SK             |      |
| 3"   | H 300SK             |      |



| Size | LOCKING CAP HANDLE |      |
|------|--------------------|------|
|      | SS                 |      |
|      | Part #             | List |
| 2"   | LH 200SS           |      |
| 3"   | LH 300SS           |      |
| 4"   | LH 400SS           |      |
| 6"   | LH 600SS           |      |

**\*NOTE REGARDING GASKETS:** All SFI couplers are supplied with Buna-N as standard. However, this sealing compound may not be compatible with all applications.

**STANDARD SIZES AND THREADS:** The size indicated for a coupler or adapter is the nominal size of pipe or hose to which it connects. Standard sizes for Seal Fast adapters and couplers are 1/2", 3/4", 1", 1-1/4", 1-1/2", 2", 2-1/2", 3", 4", 5", 6" and 8". Threaded parts are furnished with tapered pipe threads (NPT).

**DUST CAPS AND DUST PLUGS:** Dust Caps and Dust Plugs are not designed for pressure application. Caps and Plugs must be chain or cable constrained at all times.

### MAXIMUM PRESSURES FOR ALL METALS

|                 |         |
|-----------------|---------|
| 1/2"            | 125 psi |
| 3/4" through 4" | 150 psi |
| 5" through 6"   | 75 psi  |
| 8"              | 40 psi  |
| 10" through 12" | 25 psi  |

\*Recommendations based on use of mating fittings at ambient temperature of 70° F with standard Buna-N seal installed. For use at elevated temperatures or other unusual operating conditions, consult SFI.

**Warning: Working pressure may vary depending on how the couplings are attached to the hose assembly. Before operation, always check the hose assembly for proper attachment and that couplings are in working order.**

### MAXIMUM PRESSURES FOR

BANJO Polypropylene, Import Polypropylene & Nyglass

At 0° F

|                 |         |
|-----------------|---------|
| 1/2" through 2" | 100 psi |
| 3" through 4"   | 75 psi  |

At 70° F

|                 |         |
|-----------------|---------|
| 1/2" through 2" | 125 psi |
| 3" through 4"   | 75 psi  |

At 150° F

|                 |        |
|-----------------|--------|
| 1/2" through 2" | 70 psi |
| 3" through 4"   | 75 psi |





# CAM & GROOVE COUPLINGS

# GASKETS

COUPLINGS +



## REPLACEMENT GASKETS

The gasket materials listed below comprise a general guide to aid in the selection of the correct seal for customer application.

### Buna N: Color Code **Blue Stripe**

Buna N is standard. It is generally recommended for petroleum derivatives, neutral or slightly acidic salt solutions, alcohols, ethers, glycols, fats, oils, and greases. This compound should give good service from -40°F to +250°F.

### Neoprene: Color Code **Red Stripe**

Recommended for alkaline and acid salt solutions and aldehydes such as formaldehyde -65°F to 250°F.

### \*Viton A: Color Code **Green**

Recommended for aromatics, hydrocarbons, liquid chlorine, carbon disulfide and molten sulfur. Viton A is not recommended for esters or the ketone family. This compound should offer good service -40°F to 400°F.

### PTFE:

The standard PTFE gasket is an envelope type design having a Neoprene Core. PTFE is recommended for highly oxidizing fluids, esters, ketones, and other liquids not generally handled by natural and synthetic rubbers

\*PTFE encapsulated with silicon filler -40°F to 500°F.

### EPDM: Color Code **White Stripe**

Ethylene-propylene rubber. Excellent ozone, chemical, and aging resistance. Poor resistance to petroleum-based fluids. \*\*For use with 800IALPTK 8" cam-lock

### Buna N - FDA: Color Code **WHITE**

It is generally recommended for food handling, neutral or slightly acidic salt solutions, alcohols, ethers, glycols, fats, oils, and greases. This compound should give good service from -40°F to +250°F.

extra thick



## TEMPERATURE RATINGS

| Gasket Material           | Temperature Range in °F |     |     |     |     |     |     |     |
|---------------------------|-------------------------|-----|-----|-----|-----|-----|-----|-----|
|                           | 500                     | 400 | 300 | 275 | 250 | 200 | 150 | 0   |
| Buna N                    |                         |     |     | ✓   |     |     |     | -40 |
| Neoprene                  |                         |     |     |     | ✓   |     |     | -65 |
| *Viton A                  |                         | ✓   |     |     |     |     |     | -40 |
| Silicone                  | ✓                       |     |     |     |     |     |     | -30 |
| *Teflon                   | ✓                       |     |     |     |     |     |     | -40 |
| Nat. Rubber               |                         |     |     |     |     | ✓   |     | -60 |
| Butyl                     |                         |     | ✓   |     |     |     |     | -40 |
| Hypalon                   |                         |     |     |     | ✓   |     |     | -65 |
| EPDM                      |                         |     |     |     |     |     | ✓   |     |
| PTFE Encapsulated SILICON |                         | ✓   |     |     |     |     |     |     |
| PTFE Encapsulated FKM     |                         | ✓   |     |     |     |     |     |     |

\*Tetrafluoroethylene Resin by DuPont viton & teflon are registered names.

# GASKETS

# CAM & GROOVE COUPLINGS

## REPLACEMENT GASKETS

The gasket materials listed below comprise a general guide to aid in the selection of the correct seal for customer application.



| Size   | PK Qty | BUNA N     |      | BUNA N (extra thick) |      | NEOPRENE |      | VITON A |      |
|--------|--------|------------|------|----------------------|------|----------|------|---------|------|
|        |        | Part #     | List | Part #               | List | Part #   | List | Part #  | List |
| 1/2"   | 25     | 050 BN     |      | ---                  |      | 050 NE   |      | 050 VI  |      |
| 3/4"   | 25     | 075 BN     |      | ---                  |      | 075 NE   |      | 075 VI  |      |
| 1"     | 25     | 100 BN     |      | 100 BX               |      | 100 NE   |      | 100 VI  |      |
| 1-1/4" | 25     | 125 BN     |      | 125 BX               |      | 125 NE   |      | 125 VI  |      |
| 1-1/2" | 25     | 150 BN     |      | 150 BX               |      | 150 NE   |      | 150 VI  |      |
| 2"     | 25     | 200 BN     |      | 200 BX               |      | 200 NE   |      | 200 VI  |      |
| 2-1/2" | 25     | 250 BN     |      | 250 BX               |      | 250 NE   |      | 250 VI  |      |
| 3"     | 15     | 300 BN     |      | 300 BX               |      | 300 NE   |      | 300 VI  |      |
| 4"     | 10     | 400 BN     |      | 400 BX               |      | 400 NE   |      | 400 VI  |      |
| 5"     | ---    | 500 BN     |      | 500 BX               |      | 500 NE   |      | 500 VI  |      |
| 6"     | ---    | 600 BN     |      | 600 BX               |      | 600 NE   |      | 600 VI  |      |
| 8"     | ---    | 800 BN     |      | ---                  |      | ---      |      | ---     |      |
| 8"     | ---    | 800 BNPTK* |      | ---                  |      | ---      |      | ---     |      |

\*For use w/8" PTK style Cam Lock



| Size   | PK Qty | EPDM   |      | PTFE Envelope w/Neoprene |      | PTFE Envelope w/Silicone |      | PTFE Encapsulated |      |
|--------|--------|--------|------|--------------------------|------|--------------------------|------|-------------------|------|
|        |        | Part # | List | Part #                   | List | Part #                   | List | Part #            | List |
| 1/2"   | 25     | 050 EP |      | ---                      |      | ---                      |      | ---               |      |
| 3/4"   | 25     | 075 EP |      | 075 TF                   |      | ---                      |      | ---               |      |
| 1"     | 25     | 100 EP |      | 100 TF                   |      | ---                      |      | ---               |      |
| 1-1/4" | 25     | 125 EP |      | 125 TF                   |      | ---                      |      | ---               |      |
| 1-1/2" | 25     | 150 EP |      | 150 TF                   |      | ---                      |      | 150TFCAP          |      |
| 2"     | 25     | 200 EP |      | 200 TF                   |      | ---                      |      | 200TFCAP          |      |
| 2-1/2" | 25     | 250 EP |      | 250 TF                   |      | ---                      |      | 250TFCAP          |      |
| 3"     | 15     | 300 EP |      | 300 TF                   |      | 300TFS                   |      | 300TFCAP          |      |
| 4"     | 10     | 400 EP |      | 400 TF                   |      | ---                      |      | 400TFCAP          |      |
| 5"     | ---    | ---    |      | 500 TF                   |      | ---                      |      | ---               |      |
| 6"     | ---    | ---    |      | 600 TF                   |      | ---                      |      | ---               |      |

**SPECIAL NOTE REGARDING GASKETS:** All SFI couplers are supplied with Buna-N as standard. However, this sealing compound may not be compatible with all applications.



| Size   | PK Qty | PTFE Encapsulated |      |
|--------|--------|-------------------|------|
|        |        | Part #            | List |
| 1-1/2" | 25     | 150TFVCAP         |      |
| 2"     | 25     | 200TFVCAP         |      |
| 2-1/2" | 25     | 250TFVCAP         |      |
| 3"     | 25     | 300TFVCAP         |      |
| 4"     | 25     | 400TFVCAP         |      |

| Size   | PK Qty | BUNA N - FDA |      |
|--------|--------|--------------|------|
|        |        | Part #       | List |
| 3/4"   | 25     | 075 FDA      |      |
| 1"     | 25     | 100 FDA      |      |
| 1-1/4" | 25     | 125 FDA      |      |
| 1-1/2" | 25     | 150 FDA      |      |
| 2"     | 25     | 200 FDA      |      |
| 2-1/2" | 25     | 250 FDA      |      |
| 3"     | 15     | 300 FDA      |      |
| 4"     | 10     | 400 FDA      |      |
| 5"     | ---    | 500 FDA      |      |
| 6"     | ---    | 600 FDA      |      |







## FEMALE COUPLER X SHANK

▶\*Aluminum & Brass have Machined Shanks



**C**  
TYPE

| Size   | ALUMINUM |      | BRASS    |      | 316 SS   |      | PLATED IRON |      |
|--------|----------|------|----------|------|----------|------|-------------|------|
|        | Part #   | List | Part #   | List | Part #   | List | Part #      | List |
| 1"     | C 100ALC |      | C 100BRC |      | C 100SSC |      | ---         |      |
| 1-1/2" | C 150ALC |      | C 150BRC |      | C 150SSC |      | ---         |      |
| 2"     | C 200ALC |      | C 200BRC |      | C 200SSC |      | ---         |      |
| 2-1/2" | C 250ALC |      | C 250BRC |      | C 250SSC |      | ---         |      |
| 3"     | C 300ALC |      | C 300BRC |      | C 300SSC |      | C 300CIC    |      |
| 4"     | C 400ALC |      | C 400BRC |      | C 400SSC |      | C 400CIC    |      |
| 6"     | C 600ALC |      | C 600BRC |      | C 600SSC |      | ---         |      |

## MALE ADAPTER X SHANK



**E**  
TYPE

| Size   | ALUMINUM |      | BRASS    |      | 316 SS   |      | PLATED IRON |      |
|--------|----------|------|----------|------|----------|------|-------------|------|
|        | Part #   | List | Part #   | List | Part #   | List | Part #      | List |
| 1"     | E 100ALC |      | E 100BRC |      | E 100SSC |      | ---         |      |
| 1-1/2" | E 150ALC |      | E 150BRC |      | E 150SSC |      | ---         |      |
| 2"     | E 200ALC |      | E 200BRC |      | E 200SSC |      | ---         |      |
| 2-1/2" | E 250ALC |      | E 250BRC |      | E 250SSC |      | ---         |      |
| 3"     | E 300ALC |      | E 300BRC |      | E 300SSC |      | E 300CIC    |      |
| 4"     | E 400ALC |      | E 400BRC |      | E 400SSC |      | E 400CIC    |      |
| 6"     | E 600ALC |      | E 600BRC |      | E 600SSC |      | ---         |      |

Seal Fast Crimp Cam and Groove couplings are to be used with the Seal Fast Ferrules and Crimps Sleeves on pages 68-71 of this catalog. They are designed with an Interlock System which allows the Ferrule to be permanently attached to the coupling

# COMBO NIPPLES



## NPT THREADED

COUPLINGS +



| Size   | ZINC PLATED STEEL |      |
|--------|-------------------|------|
|        | Part #            | List |
| 1"     | SF100SPC          |      |
| 1-1/4" | SF125SPC          |      |
| 1-1/2" | SF150SPC          |      |
| 2"     | SF200SPC          |      |
| 2-1/2" | SF250SPC          |      |
| 3"     | SF300SPC          |      |
| 4"     | SF400SPC          |      |
| 6"     | SF600SPC          |      |



| Size   | 316 SS    |      |
|--------|-----------|------|
|        | Part #    | List |
| 1"     | SF100SS6C |      |
| 1-1/4" | SF125SS6C |      |
| 1-1/2" | SF150SS6C |      |
| 2"     | SF200SS6C |      |
| 2-1/2" | SF250SS6C |      |
| 3"     | SF300SS6C |      |
| 4"     | SF400SS6C |      |
| 6"     | SF600SS6C |      |



## WELD BEVEL

| Size   | STEEL    |      |
|--------|----------|------|
|        | Part #   | List |
| 1"     | SF100SBC |      |
| 1-1/4" | SF125SBC |      |
| 1-1/2" | SF150SBC |      |
| 2"     | SF200SBC |      |
| 2-1/2" | SF250SBC |      |
| 3"     | SF300SBC |      |
| 4"     | SF400SBC |      |
| 6"     | SF600SBC |      |



| Size   | 316 SS     |      |
|--------|------------|------|
|        | Part #     | List |
| 1"     | SF100SSB6C |      |
| 1-1/4" | ---        |      |
| 1-1/2" | SF150SSB6C |      |
| 2"     | SF200SSB6C |      |
| 2-1/2" | SF250SSB6C |      |
| 3"     | SF300SSB6C |      |
| 4"     | SF400SSB6C |      |
| 6"     | SF600SSB6C |      |



## GROOVED

| Size   | STEEL    |      |
|--------|----------|------|
|        | Part #   | List |
| 1"     | SF100SGC |      |
| 1-1/2" | SF150SGC |      |
| 2"     | SF200SGC |      |
| 3"     | SF300SGC |      |
| 4"     | SF400SGC |      |
| 6"     | SF600SGC |      |



| Size   | 316 SS     |      |
|--------|------------|------|
|        | Part #     | List |
| 1"     | SF100SSG6C |      |
| 1-1/2" | SF150SSG6C |      |
| 2"     | SF200SSG6C |      |
| 3"     | SF300SSG6C |      |
| 4"     | SF400SSG6C |      |
| 6"     | SF600SSG6C |      |



### General Uses:

Working pressures may vary with hose type and clamping system used to install couplings. Combination Nipples are recommended for low pressure discharge and suction service for compatible liquids. NOT for compressible products such as Air, Nitrogen and Steam. \*All blank end & grooved combination nipples are made using Schedule 40 pipe. Seal Fast Crimp Combination Nipples are to be used with the Seal Fast Ferrules and Crimps Sleeves on pages 38-41 of this catalog. They are designed with an Interlock System which allows the Ferrule to be permanently attached to the coupling





| Hose Size     | Wall Thickness | Length | Sleeve I.D. | Zinc Plated Steel |      | 304 SS     |      | Aluminum  |      |
|---------------|----------------|--------|-------------|-------------------|------|------------|------|-----------|------|
|               |                |        |             | Part #            | List | Part #     | List | Part #    | List |
| <b>1/2"</b>   |                |        |             |                   |      |            |      |           |      |
|               | 0.049"         | 1.30"  | 44/64"      | ---               |      | S050-044SS |      | ---       |      |
|               | 0.049"         | 1.30"  | 52/64"      | ---               |      | S050-052SS |      | ---       |      |
|               | 0.049"         | 1.30"  | 56/64"      | S050-056PS        |      | S050-056SS |      | ---       |      |
|               | 0.049"         | 1.30"  | 60/64"      | S050-060PS        |      | S050-060SS |      | ---       |      |
|               | 0.049"         | 1.30"  | 1"          | ---               |      | S050-100SS |      | ---       |      |
| <b>3/4"</b>   |                |        |             |                   |      |            |      |           |      |
|               | 0.049"         | 1.60"  | 1-4/64"     | S075-104PS        |      | S075-104SS |      | ---       |      |
|               | 0.049"         | 1.60"  | 1-8/64"     | S075-108PS        |      | S075-108SS |      | ---       |      |
|               | 0.049"         | 1.60"  | 1-12/64"    | S075-112PS        |      | S075-112SS |      | S075-112A |      |
|               | 0.049"         | 1.60"  | 1-16/64"    | S075-116PS        |      | S075-116SS |      | S075-116A |      |
|               | 0.049"         | 1.60"  | 1-20/64"    | S075-120PS        |      | S075-120SS |      | S075-120A |      |
| <b>1"</b>     |                |        |             |                   |      |            |      |           |      |
|               | 0.049"         | 2.10"  | 1-20/64"    | S100-120PS        |      | S100-120SS |      | ---       |      |
|               | 0.049"         | 2.10"  | 1-24/64"    | S100-124PS        |      | S100-124SS |      | ---       |      |
|               | 0.049"         | 2.10"  | 1-28/64"    | S100-128PS        |      | S100-128SS |      | ---       |      |
|               | 0.049"         | 2.10"  | 1-32/64"    | S100-132PS        |      | S100-132SS |      | ---       |      |
|               | 0.049"         | 2.10"  | 1-36/64"    | S100-136PS        |      | S100-136SS |      | S100-136A |      |
|               | 0.049"         | 2.10"  | 1-40/64"    | S100-140PS        |      | S100-140SS |      | S100-140A |      |
|               | 0.049"         | 2.10"  | 1-44/64"    | S100-144PS        |      | S100-144SS |      | S100-144A |      |
| <b>1-1/4"</b> |                |        |             |                   |      |            |      |           |      |
|               | 0.049"         | 2.10"  | 1-48/64"    | ---               |      | S125-148SS |      | ---       |      |
|               | 0.049"         | 2.10"  | 1-52/64"    | S125-152PS        |      | S125-152SS |      | ---       |      |
|               | 0.049"         | 2.10"  | 1-56/64"    | S125-156PS        |      | S125-156SS |      | ---       |      |
|               | 0.065"         | 2.10"  | 1-60/64"    | S125-160PS        |      | S125-160SS |      | ---       |      |
| <b>1-1/2"</b> |                |        |             |                   |      |            |      |           |      |
|               | 0.065"         | 2.10"  | 2"          | S150-200PS        |      | S150-200SS |      | S150-200A |      |
|               | 0.065"         | 2.10"  | 2-4/64"     | S150-204PS        |      | S150-204SS |      | S150-204A |      |
|               | 0.065"         | 2.10"  | 2-8/64"     | S150-208PS        |      | S150-208SS |      | S150-208A |      |
|               | 0.065"         | 2.10"  | 2-12/64"    | S150-212PS        |      | S150-212SS |      | S150-212A |      |
|               | 0.065"         | 2.10"  | 2-16/64"    | S150-216PS        |      | S150-216SS |      | S150-216A |      |
|               | 0.065"         | 2.10"  | 2-20/64"    | S150-220PS        |      | S150-220SS |      | S150-220A |      |
| <b>2"</b>     |                |        |             |                   |      |            |      |           |      |
|               | 0.065"         | 3.10"  | 2-16/64"    | S200-216PS        |      | S200-216SS |      | ---       |      |
|               | 0.065"         | 3.10"  | 2-20/64"    | S200-220PS        |      | S200-220SS |      | ---       |      |
|               | 0.065"         | 3.10"  | 2-24/64"    | S200-224PS        |      | S200-224SS |      | ---       |      |
|               | 0.065"         | 3.10"  | 2-28/64"    | S200-228PS        |      | S200-228SS |      | S200-228A |      |
|               | 0.065"         | 3.10"  | 2-32/64"    | S200-232PS        |      | S200-232SS |      | S200-232A |      |
|               | 0.065"         | 3.10"  | 2-36/64"    | S200-236PS        |      | S200-236SS |      | S200-236A |      |
|               | 0.065"         | 3.10"  | 2-40/64"    | S200-240PS        |      | S200-240SS |      | S200-240A |      |
|               | 0.065"         | 3.10"  | 2-44/64"    | S200-244PS        |      | S200-244SS |      | S200-244A |      |
|               | 0.065"         | 3.10"  | 2-48/64"    | S200-248PS        |      | S200-248SS |      | S200-248A |      |
|               | 0.065"         | 3.10"  | 2-52/64"    | S200-252PS        |      | S200-252SS |      | S200-252A |      |
|               | 0.065"         | 3.10"  | 2-56/64"    | S200-256PS        |      | S200-256SS |      | S200-256A |      |
|               | 0.065"         | 3.10"  | 2-60/64"    | S200-260PS        |      | S200-260SS |      | ---       |      |
| <b>2-1/2"</b> |                |        |             |                   |      |            |      |           |      |
|               | 0.065"         | 3.10"  | 3"          | S250-300PS        |      | S250-300SS |      | S250-300A |      |
|               | 0.065"         | 3.10"  | 3-4/64"     | S250-304PS        |      | S250-304SS |      | S250-304A |      |
|               | 0.065"         | 3.10"  | 3-8/64"     | S250-308PS        |      | S250-308SS |      | S250-308A |      |
|               | 0.065"         | 3.10"  | 3-12/64"    | S250-312PS        |      | S250-312SS |      | ---       |      |
|               | 0.065"         | 3.10"  | 3-16/64"    | S250-316PS        |      | S250-316SS |      | S250-316A |      |
|               | 0.065"         | 3.10"  | 3-20/64"    | ---               |      | S250-320SS |      | ---       |      |
|               | 0.065"         | 3.10"  | 3-24/64"    | ---               |      | S250-324SS |      | ---       |      |

# SLEEVES



COUPLINGS +



| Hose Size |                |        |             | Zinc Plated Steel |      | 304 SS     |      | Aluminum  |      |
|-----------|----------------|--------|-------------|-------------------|------|------------|------|-----------|------|
|           | Wall Thickness | Length | Sleeve I.D. | Part #            | List | Part #     | List | Part #    | List |
| <b>3"</b> |                |        |             |                   |      |            |      |           |      |
|           | 0.083"         | 3.50"  | 3-20/64"    | S300-320PS        |      | S300-320SS |      | S300-320A |      |
|           | 0.083"         | 3.50"  | 3-24/64"    | S300-324PS        |      | S300-324SS |      | ---       |      |
|           | 0.083"         | 3.50"  | 3-28/64"    | S300-328PS        |      | S300-328SS |      | ---       |      |
|           | 0.083"         | 3.50"  | 3-32/64"    | S300-332PS        |      | S300-332SS |      | S300-332A |      |
|           | 0.083"         | 3.50"  | 3-36/64"    | S300-336PS        |      | S300-336SS |      | S300-336A |      |
|           | 0.083"         | 3.50"  | 3-40/64"    | S300-340PS        |      | S300-340SS |      | S300-340A |      |
|           | 0.083"         | 3.50"  | 3-44/64"    | S300-344PS        |      | S300-344SS |      | S300-344A |      |
|           | 0.083"         | 3.50"  | 3-48/64"    | S300-348PS        |      | S300-348SS |      | S300-348A |      |
|           | 0.083"         | 3.50"  | 3-52/64"    | S300-352PS        |      | S300-352SS |      | S300-352A |      |
|           | 0.083"         | 3.50"  | 3-56/64"    | S300-356PS        |      | S300-356SS |      | S300-356A |      |
|           | 0.083"         | 3.50"  | 3-60/64"    | S300-360PS        |      | S300-360SS |      | S300-360A |      |
|           | 0.083"         | 3.50"  | 4"          | S300-400PS        |      | S300-400SS |      | S300-400A |      |
|           | 0.083"         | 3.50"  | 4-4/64"     | S300-404PS        |      | S300-404SS |      | ---       |      |
|           | 0.083"         | 3.50"  | 4-8/64"     | S300-408PS        |      | S300-408SS |      | S300-408A |      |
|           | 0.083"         | 3.50"  | 4-12/64"    | ---               |      | S300-412SS |      | ---       |      |
| <b>4"</b> |                |        |             |                   |      |            |      |           |      |
|           | 0.120"         | 4.50"  | 4-20/64     | S400-420PS        |      | S400-420SS |      | S400-420A |      |
|           | 0.120"         | 4.50"  | 4-24/64     | S400-424PS        |      | S400-424SS |      | S400-424A |      |
|           | 0.120"         | 4.50"  | 4-28/64     | S400-428PS        |      | S400-428SS |      | S400-428A |      |
|           | 0.120"         | 4.50"  | 4-32/64     | S400-432PS        |      | S400-432SS |      | S400-432A |      |
|           | 0.120"         | 4.50"  | 4-36/64     | S400-436PS        |      | S400-436SS |      | S400-436A |      |
|           | 0.120"         | 4.50"  | 4-40/64     | S400-440PS        |      | S400-440SS |      | S400-440A |      |
|           | 0.120"         | 4.50"  | 4-44/64     | S400-444PS        |      | S400-444SS |      | ---       |      |
|           | 0.120"         | 4.50"  | 4-48/64     | S400-448PS        |      | S400-448SS |      | S400-448A |      |
|           | 0.120"         | 4.50"  | 4-52/64     | S400-452PS        |      | S400-452SS |      | S400-452A |      |
|           | 0.120"         | 4.50"  | 4-56/64     | S400-456PS        |      | S400-456SS |      | S400-456A |      |
|           | 0.120"         | 4.50"  | 4-60/64     | S400-460PS        |      | S400-460SS |      | S400-460A |      |
|           | 0.120"         | 4.50"  | 5           | S400-500PS        |      | S400-500SS |      | S400-500A |      |
|           | 0.120"         | 4.50"  | 5-4/64      | S400-504PS        |      | S400-504SS |      | ---       |      |
|           | 0.120"         | 4.50"  | 5-8/64      | S400-508PS        |      | S400-508SS |      | S400-508A |      |
|           | 0.120"         | 4.50"  | 5-12/64     | ---               |      | S400-512SS |      | ---       |      |
| <b>5"</b> |                |        |             |                   |      |            |      |           |      |
|           | 0.120"         | 5.50"  | 5-40/64     | S500-540PS        |      | ---        |      | ---       |      |
| <b>6"</b> |                |        |             |                   |      |            |      |           |      |
|           | 0.125"         | 5.625" | 8-32/64     | S600-8??PS        |      | ---        |      | ---       |      |
|           | 0.125"         | 6.10"  | 6-20/64     | S600-616PS        |      | ---        |      | ---       |      |
|           | 0.125"         | 6.10"  | 6-20/64     | S600-620PS        |      | ---        |      | ---       |      |
|           | 0.125"         | 6.10"  | 6-24/64     | S600-624PS        |      | ---        |      | ---       |      |
|           | 0.125"         | 6.10"  | 6-32/64     | S600-632PS        |      | S600-632SS |      | ---       |      |
|           | 0.125"         | 6.10"  | 6-36/64     | S600-636PS        |      | ---        |      | ---       |      |
|           | 0.125"         | 6.10"  | 6-40/64     | S600-640PS        |      | ---        |      | ---       |      |
|           | 0.125"         | 6.10"  | 6-20/64     | S600-648PS        |      | ---        |      | ---       |      |
|           | 0.125"         | 6.10"  | 6-56/64     | S600-656PS        |      | S600-656SS |      | ---       |      |
|           | 0.125"         | 6.10"  | 6-60/64     | S600-660PS        |      | S600-660SS |      | ---       |      |
|           | 0.125"         | 6.10"  | 6-20/64     | S600-700PS        |      | ---        |      | ---       |      |
|           | 0.125"         | 6.10"  | 6-20/64     | S600-708PS        |      | ---        |      | ---       |      |
|           | 0.125"         | 6.10"  | 6-20/64     | S600-716PS        |      | ---        |      | ---       |      |
|           | 0.125"         | 6.10"  | 6-20/64     | S600-724PS        |      | ---        |      | ---       |      |
| <b>8"</b> |                |        |             |                   |      |            |      |           |      |
|           | 0.125"         | 6.625" | 8-32/64     | S800-8??PS        |      | ---        |      | ---       |      |
|           | 0.12"          | 8.10"  | 8-32/64     | S800-816PS        |      | ---        |      | ---       |      |
|           | 0.12"          | 8.10"  | 8-32/64     | S800-832PS        |      | ---        |      | ---       |      |
|           | 0.12"          | 8.10"  | 8-40/64     | S800-840PS        |      | ---        |      | ---       |      |
|           | 0.12"          | 8.10"  | 8-32/64     | S800-848PS        |      | ---        |      | ---       |      |
|           | 0.12"          | 8.10"  | 8-32/64     | S800-900PS        |      | ---        |      | ---       |      |
|           | 0.12"          | 8.10"  | 9-8/64      | S800-908PS        |      | ---        |      | ---       |      |
|           | 0.12"          | 8.10"  | 8-32/64     | S800-916PS        |      | ---        |      | ---       |      |
|           | 0.12"          | 8.10"  | 9-32/64     | S800-932PS        |      | ---        |      | ---       |      |
|           | 0.12"          | 8.10"  | 9-40/64     | S800-940PS        |      | ---        |      | ---       |      |
|           | 0.12"          | 8.10"  | 8-32/64     | S800-948PS        |      | ---        |      | ---       |      |





| Hose Size     |                |                |              | Zinc Plated Steel |      | 304 SS     |      |
|---------------|----------------|----------------|--------------|-------------------|------|------------|------|
|               | Wall Thickness | Ferrule Length | Ferrule I.D. | Part #            | List | Part #     | List |
| <b>1/2"</b>   |                |                |              |                   |      |            |      |
|               | 0.049"         | ---            | 56/64        | F050-056PS        |      | F050-056SS |      |
|               | 0.049"         | ---            | 60/64        | ---               |      | F050-060SS |      |
|               | 0.049"         | ---            | 1            | ---               |      | F050-100SS |      |
|               | 0.049"         | ---            | 1-4/64       | ---               |      | F050-104SS |      |
| <b>3/4"</b>   |                |                |              |                   |      |            |      |
|               | 0.049"         | ---            | 1-4/64       | F075-104PS        |      | F075-104SS |      |
|               | 0.049"         | ---            | 1-8/64       | F075-108PS        |      | F075-108SS |      |
|               | 0.049"         | ---            | 1-12/64      | F075-112PS        |      | F075-112SS |      |
|               | 0.049"         | ---            | 1-16/64      | F075-116PS        |      | F075-116SS |      |
|               | 0.049"         | ---            | 1-20/64      | F075-120PS        |      | F075-120SS |      |
|               | 0.049"         | ---            | 1-24/64      | ---               |      | F075-124SS |      |
| <b>1"</b>     |                |                |              |                   |      |            |      |
|               | 0.049"         | ---            | 1-28/64      | F100-128PS        |      | F100-128SS |      |
|               | 0.049"         | ---            | 1-32/64      | F100-132PS        |      | F100-132SS |      |
|               | 0.049"         | ---            | 1-36/64      | F100-136PS        |      | F100-136SS |      |
|               | 0.049"         | ---            | 1-40/64      | F100-140PS        |      | F100-140SS |      |
|               | 0.049"         | ---            | 1-44/64      | F100-144PS        |      | F100-144SS |      |
|               | 0.049"         | ---            | 1-48/64      | F100-148PS        |      | F100-148SS |      |
|               | 0.049"         | ---            | 1-52/64      | F100-152PS        |      | F100-152SS |      |
|               | 0.065"         | ---            | 1-56/64      | ---               |      | F100-156SS |      |
| <b>1-1/4"</b> |                |                |              |                   |      |            |      |
|               | 0.049"         | ---            | 1-36/64      | ---               |      | F125-136SS |      |
|               | 0.049"         | ---            | 1-40/64      | ---               |      | F125-140SS |      |
|               | 0.049"         | ---            | 1-44/64      | ---               |      | F125-144SS |      |
|               | 0.065"         | ---            | 1-48/64      | ---               |      | F125-148SS |      |
|               | 0.065"         | ---            | 1-52/64      | F125-152PS        |      | F125-152SS |      |
|               | 0.065"         | ---            | 1-56/64      | F125-156PS        |      | F125-156SS |      |
|               | 0.065"         | ---            | 1-60/64      | F125-160PS        |      | F125-160SS |      |
|               | 0.065"         | ---            | 2            | ---               |      | F125-200SS |      |
| <b>1-1/2"</b> |                |                |              |                   |      |            |      |
|               | 0.065"         | ---            | 1-56/64      | F150-156PS        |      | F150-156SS |      |
|               | 0.065"         | ---            | 1-60/64      | F150-160PS        |      | F150-160SS |      |
|               | 0.065"         | ---            | 2            | F150-200PS        |      | F150-200SS |      |
|               | 0.065"         | ---            | 2-4/64       | F150-204PS        |      | F150-204SS |      |
|               | 0.065"         | ---            | 2-8/64       | F150-208PS        |      | F150-208SS |      |
|               | 0.065"         | ---            | 2-12/64      | F150-212PS        |      | F150-212SS |      |
|               | 0.065"         | ---            | 2-16/64      | F150-216PS        |      | F150-216SS |      |
|               | 0.065"         | ---            | 2-20/64      | F150-220PS        |      | F150-220SS |      |
|               | 0.065"         | ---            | 2-24/64      | F150-224PS        |      | F150-224SS |      |
|               | 0.065"         | ---            | 2-28/64      | F150-228PS        |      | F150-228SS |      |

# FERRULES



COUPLINGS +



| Hose Size     |                |                |              | Zinc Plated Steel |      | 304 SS     |      |
|---------------|----------------|----------------|--------------|-------------------|------|------------|------|
|               | Wall Thickness | Ferrule Length | Ferrule I.D. | Part #            | List | Part #     | List |
|               | 0.065"         | ---            | 2-24/64      | F200-224PS        |      | ---        |      |
|               | 0.065"         | ---            | 2-28/64      | F200-228PS        |      | F200-228SS |      |
|               | 0.065"         | ---            | 2-32/64      | F200-232PS        |      | F200-232SS |      |
|               | 0.065"         | ---            | 2-36/64      | F200-236PS        |      | F200-236SS |      |
|               | 0.065"         | ---            | 2-40/64      | F200-240PS        |      | F200-240SS |      |
|               | 0.065"         | ---            | 2-44/64      | F200-244PS        |      | F200-244SS |      |
|               | 0.065"         | ---            | 2-48/64      | F200-248PS        |      | F200-248SS |      |
|               | 0.065"         | ---            | 2-52/64      | F200-252PS        |      | F200-252SS |      |
|               | 0.065"         | ---            | 2-56/64      | F200-256PS        |      | F200-256SS |      |
|               | 0.065"         | ---            | 2-60/64      | F200-260PS        |      | F200-260SS |      |
|               | 0.065"         | ---            | 3            | F200-300PS        |      | F200-300SS |      |
|               | 0.065"         | ---            | 3-4/64       | ---               |      | F200-304SS |      |
|               | 0.065"         | ---            | 3-8/64       | ---               |      | F200-308SS |      |
| <b>2-1/2"</b> |                |                |              |                   |      |            |      |
|               | 0.083"         | ---            | 2-56/64      | F250-256PS        |      | F250-256SS |      |
|               | 0.083"         | ---            | 2-60/64      | ---               |      | F250-260SS |      |
|               | 0.083"         | ---            | 3            | F250-300PS        |      | F250-300SS |      |
|               | 0.083"         | ---            | 3-4/64       | F250-304PS        |      | F250-304SS |      |
|               | 0.083"         | ---            | 3-8/64       | F250-308PS        |      | F250-308SS |      |
|               | 0.083"         | ---            | 3-12/64      | F250-312PS        |      | F250-312SS |      |
|               | 0.083"         | ---            | 3-16/64      | F250-316PS        |      | F250-316SS |      |
|               | 0.083"         | ---            | 3-20/64      | F250-320PS        |      | F250-320SS |      |
|               | 0.083"         | ---            | 3-24/64      | ---               |      | F250-324SS |      |
|               | 0.083"         | ---            | 3-32/64      | ---               |      | F250-332SS |      |
|               | 0.083"         | ---            | 3-36/64      | F250-336PS        |      | F250-336SS |      |
|               | 0.083"         | ---            | 3-48/64      | F250-348PS        |      | F250-348SS |      |
| <b>3"</b>     |                |                |              |                   |      |            |      |
|               | 0.083"         | ---            | 3-32/64      | F300-332PS        |      | F300-332SS |      |
|               | 0.083"         | ---            | 3-36/64      | F300-336PS        |      | F300-336SS |      |
|               | 0.083"         | ---            | 3-40/64      | F300-340PS        |      | F300-340SS |      |
|               | 0.083"         | ---            | 3-44/64      | F300-344PS        |      | F300-344SS |      |
|               | 0.083"         | ---            | 3-48/64      | F300-348PS        |      | F300-348SS |      |
|               | 0.083"         | ---            | 3-52/64      | F300-352PS        |      | F300-352SS |      |
|               | 0.083"         | ---            | 3-56/64      | F300-356PS        |      | F300-356SS |      |
|               | 0.083"         | ---            | 3-60/64      | F300-360PS        |      | F300-360SS |      |
|               | 0.083"         | ---            | 4            | F300-400PS        |      | F300-400SS |      |
|               | 0.083"         | ---            | 4-4/64       | ---               |      | F300-404SS |      |
|               | 0.083"         | ---            | 4-8/64       | F300-408PS        |      | F300-408SS |      |
| <b>4"</b>     |                |                |              |                   |      |            |      |
|               | 0.120"         | ---            | 4-24/64      | F400-424PS        |      | F400-424SS |      |
|               | 0.120"         | ---            | 4-32/64      | F400-432PS        |      | F400-432SS |      |
|               | 0.120"         | ---            | 4-36/64      | F400-436PS        |      | F400-436SS |      |
|               | 0.120"         | ---            | 4-40/64      | F400-440PS        |      | F400-440SS |      |
|               | 0.120"         | ---            | 4-44/64      | F400-444PS        |      | F400-444SS |      |
|               | 0.120"         | ---            | 4-48/64      | F400-448PS        |      | F400-448SS |      |
|               | 0.120"         | ---            | 4-52/64      | F400-452PS        |      | F400-452SS |      |
|               | 0.120"         | ---            | 4-56/64      | F400-456PS        |      | F400-456SS |      |
|               | 0.120"         | ---            | 4-60/64      | F400-460PS        |      | F400-460SS |      |
|               | 0.120"         | ---            | 5            | F400-500PS        |      | F400-500SS |      |
|               | 0.120"         | ---            | 5-4/64       | F400-504PS        |      | F400-504SS |      |
|               | 0.120"         | ---            | 5-16/64      | ---               |      | F400-516SS |      |
| <b>5"</b>     |                |                |              |                   |      |            |      |
|               | 0.120"         | ---            | 5-60/64      | F500-560PS        |      | ---        |      |
| <b>6"</b>     |                |                |              |                   |      |            |      |
|               | 0.125"         | ---            | 6-4/64       | F600-604PS        |      | ---        |      |
|               | 0.125"         | ---            | 6-40/64      | F600-640PS        |      | ---        |      |
|               | 0.125"         | ---            | 6-56/64      | F600-656PS        |      | F600-656SS |      |
|               | 0.125"         | ---            | 6-60/64      | F600-660PS        |      | F600-660SS |      |
|               | 0.125"         | ---            | 7            | F600-700PS        |      | ---        |      |
|               | 0.125"         | ---            | 7-4/64       | F600-704PS        |      | F600-704SS |      |
|               | 0.125"         | ---            | 7-12/64      | F600-712PS        |      | ---        |      |



## SF CRIMP PROCESS

### STEP 1

**Cut** hose end square & clean any debris from tube interior.



### STEP 2

**Measure** the outer diameter (OD) of the hose.

Based on the OD, select the proper ferrule size.



### STEP 3

**Slide** the ferrule over the shank up to the collar.

Insert the shank into the hose squarely. Be careful you do not damage the tube! Only use lubrication if necessary.

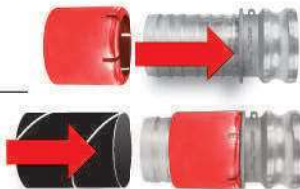

### STEP 4

**Select** the desired crimp length & crimp OD.

Using the crimp machine manufacturer's recommendations, select the proper die set.

Place the hose assembly into the die opening.



### STEP 5

**JOG** the crimp dies until they contact the ferrule.

Be sure the ferrule and crimp dies are lined up properly to achieve the desired crimp length.

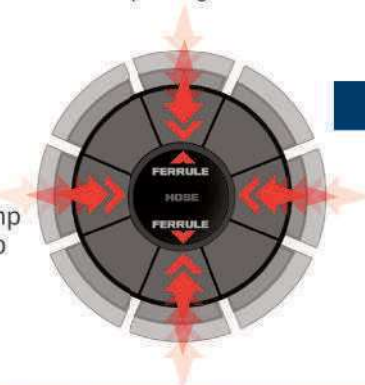

### STEP 6

**Crimp** the ferrule to the desired diameter.



### STEP 7

**Retract** the dies and remove the hose assembly.

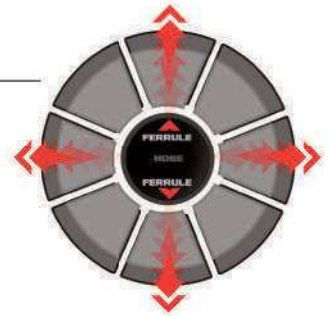

### STEP 8

**Measure** the crimp diameter to ensure it meets the desired dimension.



### STEP 9

**If** the OD is too *large*, re-crimp the ferrule until it meets the required specification. If the diameter is too *small*, please check all data again. If no mistakes were made, please contact Seal Fast.

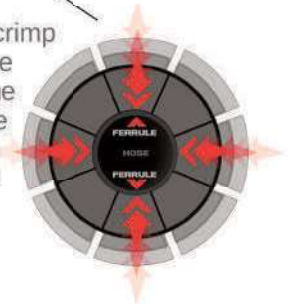

### STEP 10

**Repeat** Steps 1-10 for the other end.

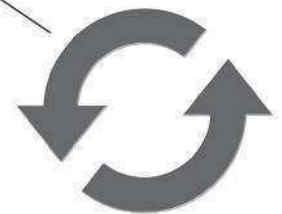

## DISCLAIMER!

The above crimp steps are taken from the NAHAD Hose Assembly Guidelines. This is a general guide only, it is not meant to be an all inclusive manual for crimping. Seal Fast recommends that only experienced operators perform the crimping procedures. Crimp specifications are not perfect. Hoses vary from manufacturer to manufacturer, and the hardness or softness (durometer) of the cover and tube can cause crimp specifications to vary. It is essential that all crimped assemblies are tested prior to being delivered to customers. Seal Fast recommends taking the necessary steps to determine crimp specs for each application, as opposed to using a chart provided by a manufacturer. This is especially important if you mix and match ferrules/sleeves and fittings from different manufacturers. Seal Fast cannot guarantee assemblies if the ferrules/sleeves and fittings are not both purchased from Seal Fast.



**INTERESTED  
IN YOUR OWN  
CRIMPING MACHINE**



COUPLINGS +

**OR EMAIL SALES  
FOR DETAILS ON OWNING YOUR OWN  
CRIMPING MACHINE**

**38**



# FUEL TANKER

# LIQUID

## API VALVES - BOTTOM LOADING/UNLOADING ADAPTER

COUPLINGS +



- Heat-treated aluminum construction with a **Brass Ring**.
- One-piece heavy-duty poppet & SS trim for longer life.
- Multi-position short stroke aluminum handle w/Smooth rotation of less than 60°.
- Flat bottom body eliminate product accumulation after
- Large inside diameter for higher flow rate at 290 gallons per
- Meets API RP-1004 specifications with a standard 4" TTMA flange.
- Viton\* Seals

\*Viton is a registered trademarks of DuPont Dow Elastomers.

| Size | ALUMINUM |      |
|------|----------|------|
|      | Part #   | List |
| 4"   | 106AH    |      |

## API VALVES w/SIGHT GLASS - BOTTOM LOADING/UNLOADING ADAPTER



- 4" Adapter Openable **Sight Glass - Bottom Loading**.
- Fluid Flow Sight Level
- Heat-treated aluminum construction with a **Brass Ring**.
- One-piece heavy-duty poppet & SS trim for longer life.
- Multi-position short stroke aluminum handle w/Smooth rotation of less than 60°.
- Flat bottom body eliminate product accumulation after
- Large inside diameter for higher flow rate at 290 gallons per
- Meets API RP-1004 specifications with a standard 4" TTMA flange.
- Viton\* Seals

\*Viton is a registered trademarks of DuPont Dow Elastomers.

| Size        | ALUMINUM             |      |
|-------------|----------------------|------|
|             | Part #               | List |
| 4"          | 106AHS w/Sight Glass |      |
| sight glass | 106SGK               |      |



## API VALVES - BOTTOM LOAD ONLY

▶ Viton® Seals



Use w/Part# 1004GH

- Construction 1 pcs with TTMA 4" flange.
- Heat-treated aluminum construction with a brass ring.
- Meets API RP-1004 specifications.
- Viton® Seals

\*Viton is a registered trademarks of DuPont Dow Elastomers.

| Size       | ALUMINUM |      |
|------------|----------|------|
|            | Part #   | List |
| 4"         | 106A     |      |
| repair kit | RK106    |      |

## API GRAVITY ADAPTER - COUPLER X FEMALE NPT

▶ Handle Actuated



Use w/Part# 106A

- Aluminum alloy construction w/Self-locking device
- Meets API RP-1004 specs protects poppet face of API head.
- Cam handle and lug designed for one hand operation.
- Buna-N Gasket standard.
- Interchangeable with competitor's items made to the same specifications.

| Size               | ALUMINUM |      |
|--------------------|----------|------|
|                    | Part #   | List |
| 4" x 4"            | 1004GH   |      |
| replacement gasket | 1004GR   |      |

## API DUST CAP



- Aluminum alloy construction w/Self-locking device.
- Meets API RP-1004 specification protects poppet face of API head.
- Nylon-Glass cam handle w/Self-locking feature reduces wear and is non-corrosive.
- Cam handle & lug designed for one hand operation.
- Buna-N gasket standard.
- Interchangeable with competitor's items made to the same specifications.

| Size       | ALUMINUM |      |
|------------|----------|------|
|            | Part #   | List |
| 4"         | 1004DC   |      |
| RPL Handle | 1004CHRK |      |
| Gasket     | 1004DR   |      |



1004CHRK - Replacement Handle



1004DR - Replacement Gasket for API Cap

## USE WITH API VALVES

USE WITH



SIGHT GLASS p.53



EORH GASKETS p.53



# FUEL TANKER

# LIQUID

COUPLINGS +



## GRAVITY DROP ADAPTER

▶ Available w/Self Locking Handles



TYPE **GA**

- Attach directly against openable API's.
- Allows drop hose with standard Seal Fast cam and groove couplings to clamp on and transfer petroleum from the API valve.
- Meets API RP-1004 specifications.
- Heat treated aluminum alloy.
- With stainless steel self-locking handles.

| ALUMINUM w/SS Self Locking Handles |            |      |
|------------------------------------|------------|------|
| Size                               | Part #     | List |
| 3"                                 | 1004GA-300 |      |
| 4"                                 | 1004GA-400 |      |
| replacement gasket                 | 1004GR     |      |



TYPE **GA**

- Attach directly against openable API's.
- Allows drop hose with standard Seal Fast cam and groove couplings to clamp on and transfer petroleum from the API valve.
- Meets API RP-1004 specifications.
- Heat treated aluminum alloy.
- With brass handles.

| ALUMINUM w/Brass Handles |             |      |
|--------------------------|-------------|------|
| Size                     | Part #      | List |
| 3"                       | 1004GA-300B |      |
| 4"                       | 1004GA-400B |      |
| replacement gasket       | 1004GR      |      |

## GRAVITY DROP COUPLER

▶ Available w/Self Locking Handles



TYPE **GB**

- Attach directly against openable API's.
- Allows drop hose with standard Seal Fast cam and groove couplings to clamp on and transfer petroleum from the API valve.
- Meets API RP-1004 specifications.
- Heat treated aluminum alloy.
- With stainless steel self-locking handles.

| ALUMINUM           |            |      |
|--------------------|------------|------|
| Size               | Part #     | List |
| 3"                 | 1004GB-300 |      |
| 4"                 | 1004GB-400 |      |
| replacement gasket | 1004GR     |      |

## GRAVITY DROP ADAPTER - TWO PIECE

► Available w/Self Locking Handles

COUPLINGS +



see on p.49

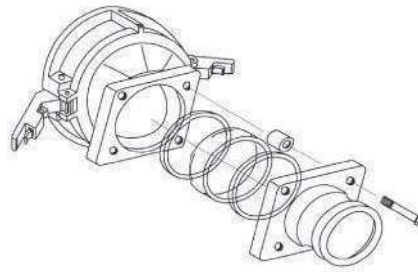

**BUILD YOUR ADAPTER**



REPLACEMENT GASKETS p.51

| Size | ALUMINUM - Gravity Drop Two Piece |      |   | ALUMINUM - Adapter & Couplers |      |                                      |
|------|-----------------------------------|------|---|-------------------------------|------|--------------------------------------|
|      | Part #                            | List | Features                                  | Part #                        | List | Features                             |
| 3"   | 1004GF-300AS                      |      | Male Adapter Straight                     | AF-300                        |      | Male Adapter Straight                |
| 3"   | 1004GF-301AS                      |      | Male Adapter Off-set                      | AF-301                        |      | Male Adapter Off-set                 |
| 4"   | 1004GF-400AS                      |      | Male Adapter Straight                     | AF-400                        |      | Male Adapter Straight                |
| 3"   | 1004GF-300BLS                     |      | Female w/Sight Glass                      | BF-300                        |      | Female Coupler                       |
| 4"   | 1004GF-400BLS                     |      | Female w/Sight Glass                      | BF-400                        |      | Female Coupler                       |
| 3"   | 1004GF-300SB                      |      | Male Threaded w/Sight Glass 1004GF-300ASB | BF-300SK                      |      | Female Coupler w/Self Locking Handle |
| 4"   | 1004GF-400SB                      |      | Male Threaded w/Sight Glass 1004GF-400ASB | BF-400SK                      |      | Female Coupler w/Self Locking Handle |
| 3"   | 1004GF-300A                       |      | Male Adapter w/Out Sight Glass            | MTF-300                       |      | Male Threaded                        |
| 4"   | 1004GF-400A                       |      | Male Adapter w/Out Sight Glass            | MTF-400                       |      | Male Threaded                        |
| 3"   | 1004GF-300BL                      |      | Female Coupler w/Out Sight Glass          | FTF-300                       |      | Female Threaded                      |
| 4"   | 1004GF-400BL                      |      | Female Coupler w/Out Sight Glass          | FTF-400                       |      | Female Threaded                      |

| Size | ALUMINUM - Gravity Drop Two Piece w/Sight - PARTS LIST |      |  |
|------|--|------|--|
|      | Part #   | List | Features   |
| Kit  | 1004GF   |      | Flange Gravity Drop Body                               |
| Kit  | 1004SGK  |      | Sight Glass Kit (918SGK - same item as item # 1004SGK) |



# FUEL TANKER

# LIQUID

COUPLINGS +

## DROP ELBOW - 918 SERIES DUAL POINT "D" HANDLE

► Overall Height = 18.25"

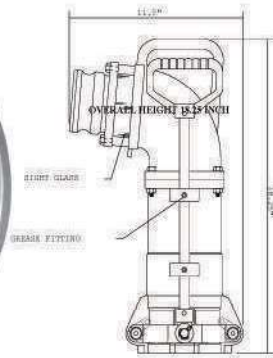

- Heavy duty aluminum alloy construction, center of gravity at handle, easy to operate.
  - Push to couple, pull to release.
  - Unique locking action that insure positive connection & uniform seal compression.
  - 360 degree round sight glass window on top.
  - 5 degree angled four bolt flange pattern with variety of different inlets to meet any requirement.
- Weight: 14.5 lb

| DETAILS                     | *ALUMINUM |      |
|-----------------------------|-----------|------|
|                             | Part #    | List |
| Body Only                   | 918B      |      |
| Inlet AF-300 w/ Sight Glass | 918-300AS |      |
| Inlet AF-400 w/ Sight Glass | 918-400AS |      |
| Inlet BF-400 w/ Sight Glass | 918-400BS |      |

| REPAIR PARTS                       | Part #                      | List |
|------------------------------------|-----------------------------|------|
|                                    | Gasket Connect Fill Adapter | 901G |
| Gasket Connect Fill Adapter Viton* | 901G-V                      |      |
| Sight Glass Kit                    | 918SGK                      |      |
| No Sight Glass Kit                 | 918NSK                      |      |

\*Tetrafluorethylene Resin by DuPont viton & teflon are registered names.

**INLET/OUTLET:** Options see p.49 - or other assemblies available upon request.

## FILL ADAPTER - TOP SEAL DUAL POINT

► Female Thread available in 3" & 4"

- Integral internal wrenching lugs.
- Models incorporate dual notches in the base to accept locking clamp.
- Manufactured from durable materials as aluminum alloy & brass.
- Standard overall height 2-15/16".

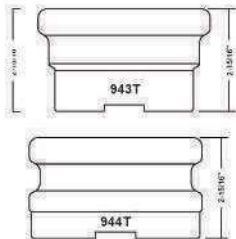

| DETAILS | ALUMINUM |      | BRASS  |      |
|---------|----------|------|--------|------|
|         | Part #   | List | Part # | List |
| 4" x 3" | 943TA    |      | 943TB  |      |
| 4" x 4" | 944TA    |      | 944TB  |      |



## DROP ADAPTER - 919 SERIES DUAL POINT LEVER HANDLE

► Overall Height = 19.25"

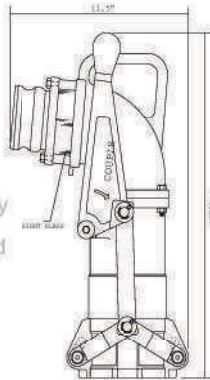

- Heavy duty aluminum alloy construction, center of gravity at handle, easy to operate.
- Unique locking action that insure positive connection and uniform seal compression.
- 360 degree round sight glass window on top.
- 5 degree angled four bolt flange pattern with variety of different inlets to meet any requirement.



| DETAILS                     | *ALUMINUM |      |
|-----------------------------|-----------|------|
|                             | Part #    | List |
| Body Only                   | 919B      |      |
| Inlet AF-300 w/ Sight Glass | 919-300AS |      |
| Inlet AF-400 w/ Sight Glass | 919-400AS |      |
| Inlet BF-400 w/ Sight Glass | 919-400BS |      |

| REPAIR PARTS                       | *ALUMINUM |      |
|------------------------------------|-----------|------|
|                                    | Part #    | List |
| Gasket Connect Fill Adapter        | 901G      |      |
| Gasket Connect Fill Adapter Viton* | 901G-V    |      |
| Sight Glass Kit                    | 918SGK    |      |
| No Sight Glass Kit                 | 918NSK    |      |

\*Tetrafluorethylene Resin by DuPont viton & teflon are registered names.  
**INLET/OUTLET:** Options see p.49 - or other assemblies available upon request.

## EXTENSION KIT - FOR 919 ELBOW



| DETAILS      | ALUMINUM |      |
|--------------|----------|------|
|              | Part #   | List |
| 5" x 5" x 3" | 919EK    |      |

| Size      | CORK   |      |
|-----------|--------|------|
|           | Part # | List |
| Universal | 818CG  |      |



# FUEL TANKER

# LIQUID

## COAXIAL DROP ELBOW - 922 SERIES SINGLE POINT LEVER HANDLE

- ▶ Overall Height: 922 = 22.4"
- 926 = 26"

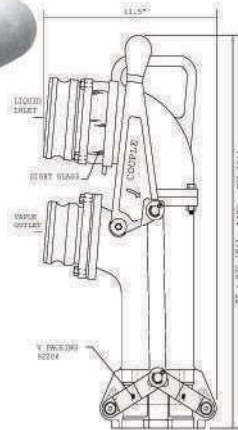

- Heavy duty aluminum alloy construction.
- Center of gravity at handle for easy operation.
- Unique locking action that insure positive connection and uniform seal compression at fill adapter.
- Product port (liquid inlet) on top and vapor port on bottom to eliminate vapor interference when draining product.
- 360 degree round sight glass on top for easy monitoring.
- 5 degree angled four bolt flange pattern with variety of different inlets and outlets to meet any requirement.
- Coaxial elbows meet stage 1 & 2 vapor recovery standards.

### \*ALUMINUM

|       | INLET LIQUID                |      | OUTLET VAPOR |            |
|-------|-----------------------------|------|--------------|------------|
|       | Part #                      | List | Part #       | List       |
| 22.4" | Body Only                   |      | 922B         | 922B       |
|       | Inlet AF-400 w/ Sight Glass |      | AF-300       | 922-4AS-3A |
| 26"   | Body Only                   |      | 926B         | 926B       |
|       | Inlet AF-400 w/ Sight Glass |      | AF-300       | 926-4AS-3A |

### REPAIR PARTS

|                                    | Part # | List |
|------------------------------------|--------|------|
| Gasket Connect Fill Adapter        | 901G   |      |
| Gasket Connect Fill Adapter Viton* | 901G-V |      |
| Sight Glass Kit                    | 918SGK |      |
| No Sight Glass Kit                 | 918NSK |      |

\*VITON is a registered trademark of DuPont Dow Elastomer

**INLET/OUTLET:** Options see p.49 - or other assemblies available upon request

## FILL ADAPTER - TOP SEAL DUAL POINT

- ▶ Female Thread available in 4"

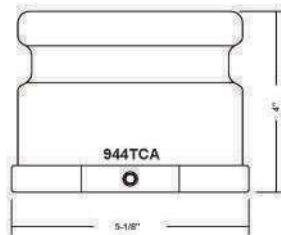

- Integral internal wrenching lugs.
- Models incorporate dual notches in the base to accept locking clamp.
- Manufactured from durable materials as aluminum alloy & brass.
- Standard overall height 2-15/16".

### DETAILS

4" x 4"

### ALUMINUM

| Part # | List |
|--------|------|
| 944TCA |      |





## FUEL INLET/OUTLET - ADAPTER Straight

USE WITH: 818, 918, 919, 922 Elbow, 926

|                       | Size | ALUMINUM |      |
|-----------------------|------|----------|------|
|                       |      | Part #   | List |
| Male Adapter Straight | 2"   | AF-200   |      |
| Male Adapter Straight | 3"   | AF-300   |      |
| Male Adapter Off-Set  | 3"   | AF-301   |      |
| Male Adapter Straight | 4"   | AF-400   |      |



## FUEL INLET/OUTLET - COUPLER

USE WITH: 818, 918, 919, 922 Elbow, 926

|                         | Size | ALUMINUM |      |
|-------------------------|------|----------|------|
|                         |      | Part #   | List |
| Female Coupler Straight | 3"   | BF-300   |      |
| Female Coupler Straight | 4"   | BF-400   |      |
| Female Coupler Off-Set  | 3"   | BF-300SK |      |
| Female Coupler Straight | 4"   | BF-400SK |      |



## FUEL INLET/OUTLET - MALE NPT

USE WITH: 818, 918, 919, 922 Elbow, 926

|               | Size | ALUMINUM |      |
|---------------|------|----------|------|
|               |      | Part #   | List |
| Male Threaded | 3"   | MTF-300  |      |
| Male Threaded | 4"   | MTF-400  |      |



## FUEL INLET/OUTLET - FEMALE NPT

USE WITH: 818, 918, 919, 922 Elbow, 926

|                 | Size | ALUMINUM |      |
|-----------------|------|----------|------|
|                 |      | Part #   | List |
| Female Threaded | 3"   | FTF-300  |      |
| Female Threaded | 4"   | FTF-400  |      |



## FUEL INLET/OUTLET - CHECK POPPET VALVE

|                    | Size | ALUMINUM |      |
|--------------------|------|----------|------|
|                    |      | Part #   | List |
| Check Poppet Valve | 3"   | AF-300CP |      |



## CORK GASKET

| Size      | CORK   |      |
|-----------|--------|------|
|           | Part # | List |
| Universal | 818CG  |      |







# FUEL TANKER

## MALE ADAPTER X TTMA



| Size    | ALUMINUM    |      |
|---------|-------------|------|
|         | Part #      | List |
| 3"      | A300TTMAAL  |      |
| 3" x 4" | A3040TTMAAL |      |
| 4"      | A400TTMAAL  |      |
| 6"      | A600TTMAAL  |      |

# LIQUID

## FEMALE COUPLER X TTMA



| Size | ALUMINUM   |      |
|------|------------|------|
|      | Part #     | List |
| 3"   | C300TTMAAL |      |
| 4"   | ---        |      |
| 6"   | C400TTMAAL |      |
| 8"   | C600TTMAAL |      |

## FEMALE NPT X TTMA



| Size | ALUMINUM      |      |
|------|---------------|------|
|      | Part #        | List |
| 3"   | FNPT300TTMAAL |      |
| 4"   | FNPT400TTMAAL |      |

## MALE NPT X TTMA



| Size | ALUMINUM      |      |
|------|---------------|------|
|      | Part #        | List |
| 3"   | MNPT300TTMAAL |      |
| 4"   | MNPT400TTMAAL |      |

# COMPONENTS

# FUEL TANKER

COUPLINGS +



## VAPOR CAP



- Orange Color Coding
- Ny-glass lockable pull out handle w/SS arms.
- Can be locked from either side of handle.
- Ability to add safety chains to cap from either side.
- One hand operation to open or close.



**WARNING: NOT FOR PRESSURE APPLICATIONS**

| ORANGE NYLON |        | GASKET  |      |
|--------------|--------|---------|------|
| Size         | Part # | Part #  | List |
| 4"           | 840DC  | G-940DC |      |

## PNEUMATIC AIR INTERLOCK VALVE



- Brass forged body w/All SS components.
- \*Unique design with filter.
- Adjustable contact pad & shaft accommodates competitive API's and other application.
- 1/4" NPT installs pneumatic connection.
- Can be installed as normally closed or open valve.
- Can be installed as top side or bottom side (up side down) to connect API's bottom loading adapter or vapor recovery adapter.

| BRASS               |        |      |
|---------------------|--------|------|
| Details             | Part # | List |
| Valve               | 800    |      |
| Repair Kit (Pad)    | 800-PA |      |
| Repair Kit (Gasket) | 800-RK |      |

## SIGHT GLASS KIT



| Details             |  | Size | ACRYLIC           |      |
|---------------------|--|------|-------------------|------|
|                     |  |      | Part #            | List |
| 1 pcs Solid Acrylic |  | 4"   | 1004SGK or 918SGK |      |

## SIGHT GLASS - TTMA FLANGE



| Details             |  | Size | ACRYLIC   |      |
|---------------------|--|------|-----------|------|
|                     |  |      | Part #    | List |
| 1 pcs Solid Acrylic |  | 4"   | ASG-400TF |      |

## CORK GASKET - FUEL INLET/OUTLET



| Details   |  | CORK   |      |
|-----------|--|--------|------|
|           |  | Part # | List |
| Universal |  | 818CG  |      |

## CORK GASKET - TTMA FLANGE



|      |  | TTMA Flange Pattern |      |
|------|--|---------------------|------|
| Size |  | CORK                |      |
|      |  | Part #              | List |
| 4"   |  | C-400TTMA           |      |

## TUBE CAP



| Size |  | ALUMINUM |      |
|------|--|----------|------|
|      |  | Part #   | List |
| 8"   |  | TC800AL  |      |

## DUST CAP - API

### Self Locking Handle

- Aluminum alloy construction w/Self-locking device - Buna-N gasket standard.
- Meets API RP-1004 specification protects poppet face of API head.
- Nylon-Glass cam handle w/Self-locking feature reduces wear & is non-corrosive.
- Cam handle & lug designed for one hand operation.
- Interchangeable w/Competitor's items made to the same specifications.

| Size       |  | ALUMINUM |      |
|------------|--|----------|------|
|            |  | Part #   | List |
| 4"         |  | 1004DC   |      |
| RPL Handle |  | 1004CHRK |      |
| Gasket     |  | 1004DR   |      |





# FUEL TANKER

# VAPOR

## DROP ELBOW - 818 SERIES DUAL POINT

▶ Overall Height = 18"

COUPLINGS +

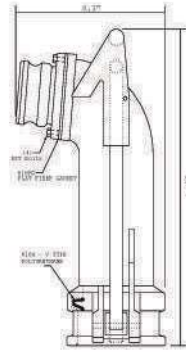

- Push to couple, push and squeeze to release.
- One piece aluminum alloy construction, easy to operate.
- Five degree angled four bolt flange pattern with variety of different outlets to meet any requirement.
- Polyurethane V type gasket
- Overall height 18"

|               | *ALUMINUM |      |
|---------------|-----------|------|
| DETAILS       | Part #    | List |
| Body Only     | 818B      |      |
| Outlet AF-300 | 818-300A  |      |
| Outlet AF-400 | 818-400A  |      |

|                            | Part # | List |
|----------------------------|--------|------|
| REPAIR PARTS               |        |      |
| Flat Fiber Gasket          | 818FG  |      |
| V Type Gasket Polyurethane | 818G   |      |

\*Tetrafluorethylene Resin by DuPont viton & teflon are registered names.

**INLET/OUTLET:** Options see p.49 - or other assemblies available upon request.



## POPPET ASSEMBLY ADAPTER - DUAL POINT SWIVEL ADAPTER

► Poppet Assembly Is Integrated w/Swivel Top Section

- Lower profile design reduces the need to adjust the riser pipe & spill bucket.
- Swivel top section that rotates 360° w/Product or vapor elbow movement while the swivel bottom section remains securely sealed to riser pipe.
- Viton gasket & PTFE-silicone O-ring seals provide compatibility w/All current fuels and fuel additives, including the proposed ethanol additive. No lubrication required, complete w/SS Socket screws.
- Female thread available w/ 3" and 4" NPSH to meet all riser pipe requirements.

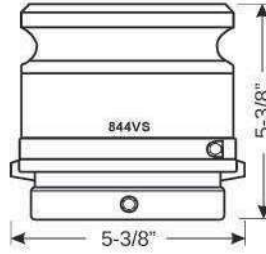

| Size    | ALUMINUM |      | BRASS  |      |
|---------|----------|------|--------|------|
|         | Part #   | List | Part # | List |
| 4" x 3" | 843VSA   |      | 843VSB |      |
| 4" x 4" | 844VSA   |      | 844VSB |      |

## POPPET ASSEMBLY ADAPTER - DUAL POINT POPPET ADAPT

► Female Thread available in 3" & 4"

- Low profile design overall height 4-9/16".
- Models incorporate dual notches in the base to accept locking clamp.
- Poppeted adapter w/SS & stem for corrosion resistance.

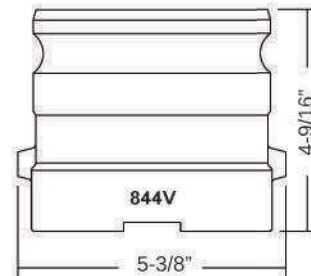
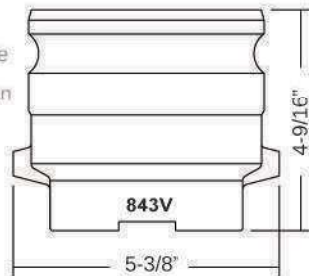

843VA



844VA



843VB



844VB

| Size    | ALUMINUM |      | BRASS  |      |
|---------|----------|------|--------|------|
|         | Part #   | List | Part # | List |
| 4" x 3" | 843VA    |      | 843VB  |      |
| 4" x 4" | 844VA    |      | 844VB  |      |



# FUEL TANKER

# VAPOR

## ADAPTER X 3" MALE NPSH W/POPPET



- Vapor adapter poppet with 3" Cam & Groove adapter and 3" Male NPSH threads into vapor return when a poppet is required.
- Used w/CVR Coupler in hose.

| SIZES   | ALUMINUM |      |
|---------|----------|------|
|         | Part #   | List |
| 3" x 3" | 833F     |      |

## VAPOR RECOVERY COUPLER w/PROBE

▶ Available w/Self Locking Handles

- CVR can be used with 833F, 843A-1, 843A, 844A-1 & 844A



| SIZES   | HANDLE          | ALUMINUM     |      |
|---------|-----------------|--------------|------|
|         |                 | Part #       | List |
| 3"      | Brass           | CVR 300AL    |      |
| 4"      | Brass           | CVR 400AL    |      |
| 4" x 3" | Brass           | CVR4030AL    |      |
| 3"      | SS-Self Locking | CVR 300ALSK  |      |
| 4"      | SS-Self Locking | CVR 400ALSK  |      |
| 4" x 3" | SS-Self Locking | CVR 4030ALSK |      |

## VAPOR ADAPTER W/POPPET X 3" or 4" FEMALE NPSH

▶ Use w/CVR 400AL or CVR 4030AL

- Vapor adapter poppet with 4" Cam & Groove and 3" female NPSH



| SIZES   | ALUMINUM |      |
|---------|----------|------|
|         | Part #   | List |
| 4" x 3" | 843A-1   |      |
| 4" x 4" | 844A-1   |      |

| SIZES   | HARDCOAT ALUMINUM |      |
|---------|-------------------|------|
|         | Part #            | List |
| 4" x 3" | 843A              |      |
| 4" x 4" | 844A              |      |



## FILL CAPS



- Grey Color Coding
- Ny-glass lockable pull out handle w/SS arms.
- Can be locked from either side of handle.
- Ability to add safety chains to cap from either side.
- One hand operation to open or close.

**WARNING: NOT FOR PRESSURE APPLICATIONS**

| Size | GREY NYLON |      | GASKET  |      |
|------|------------|------|---------|------|
|      | Part #     | List | Part #  | List |
| 4"   | 940DC      |      | G-940DC |      |

COUPLINGS + 

## PNEUMATIC 3" VAPOR VALVE FOR 16" & 20" MAN HOLE COVER

- Poppet opens into tank to prevent leakage from surges or from overturned tank. 7.354 square inches of flow area.
- Hard anodized aluminum hood and low profile.
- Tapered seat design with Viton O-ring seal provides leaktight seal.
- SS spring, screws, bolts, and nuts resists corrosion.
- 1/4" NPT external pneumatic connection.
- P/N: 820P Installs easily off-set in 20" manhole or separate 3" TTMA size mounting ring.



816P - 3" Vent



820P - 3" Vent

| Size             | ALUMINUM |      |
|------------------|----------|------|
|                  | Part #   | List |
| 3" x 16" Manhole | 816P     |      |
| 3" x 20" Manhole | 820P     |      |
| Repair Kit       | 816P-RK  |      |
| Repair Kit       | 820P-RK  |      |

## FILL ADAPTER WRENCH

| STEEL  |      |
|--------|------|
| Part # | List |
| WT-890 |      |





# FUEL TANKER

# REPAIR DIAGRAMS

## API VALVES - 106AH & 106AHS PARTS LIST

COUPLINGS +

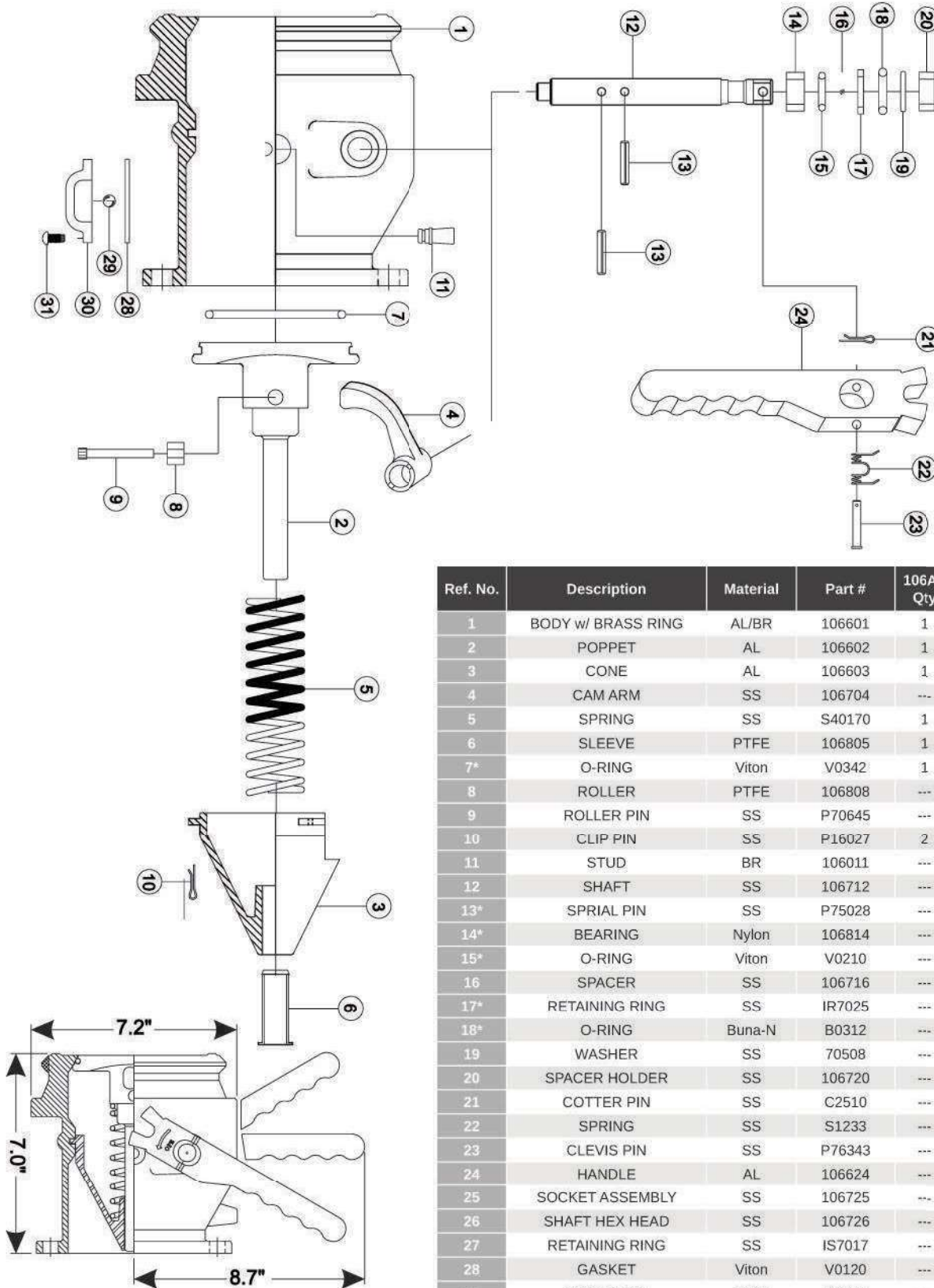

| Ref. No. | Description        | Material | Part # | 106A - Qty | 106AH - Qty | 106AHS - Qty |
|----------|--------------------|----------|--------|------------|-------------|--------------|
| 1        | BODY w/ BRASS RING | AL/BR    | 106601 | 1          | 1           | 1            |
| 2        | POPPET             | AL       | 106602 | 1          | 1           | 1            |
| 3        | CONE               | AL       | 106603 | 1          | 1           | 1            |
| 4        | CAM ARM            | SS       | 106704 | -          | 1           | 1            |
| 5        | SPRING             | SS       | S40170 | 1          | 1           | 1            |
| 6        | SLEEVE             | PTFE     | 106805 | 1          | 1           | 1            |
| 7*       | O-RING             | Viton    | V0342  | 1          | 1           | 1            |
| 8        | ROLLER             | PTFE     | 106808 | -          | 1           | 1            |
| 9        | ROLLER PIN         | SS       | P70645 | -          | 1           | 1            |
| 10       | CLIP PIN           | SS       | P16027 | 2          | 2           | 2            |
| 11       | STUD               | BR       | 106011 | -          | 1           | 1            |
| 12       | SHAFT              | SS       | 106712 | -          | 1           | 1            |
| 13*      | SPRIAL PIN         | SS       | P75028 | -          | 2           | 2            |
| 14*      | BEARING            | Nylon    | 106814 | -          | 1           | 1            |
| 15*      | O-RING             | Viton    | V0210  | -          | 1           | 1            |
| 16       | SPACER             | SS       | 106716 | -          | 1           | 1            |
| 17*      | RETAINING RING     | SS       | IR7025 | -          | 1           | 1            |
| 18*      | O-RING             | Buna-N   | B0312  | -          | 1           | 1            |
| 19       | WASHER             | SS       | 70508  | -          | 1           | 1            |
| 20       | SPACER HOLDER      | SS       | 106720 | -          | 1           | 1            |
| 21       | COTTER PIN         | SS       | C2510  | -          | 1           | 1            |
| 22       | SPRING             | SS       | S1233  | -          | 1           | 1            |
| 23       | CLEVIS PIN         | SS       | P76343 | -          | 1           | 1            |
| 24       | HANDLE             | AL       | 106624 | -          | 1           | 1            |
| 25       | SOCKET ASSEMBLY    | SS       | 106725 | -          | -           | -            |
| 26       | SHAFT HEX HEAD     | SS       | 106726 | -          | -           | -            |
| 27       | RETAINING RING     | SS       | IS7017 | -          | -           | -            |
| 28       | GASKET             | Viton    | V0120  | -          | -           | 1            |
| 29       | FLOAT BALL         | PVC      | 30031  | -          | -           | 1            |
| 30       | SIGHT GLASS        | Acrylic  | 30030  | -          | -           | 1            |
| 31       | SCREW              | SS       | 73705  | -          | -           | 4            |

\* Repair Kit RK106 Includes REF. NO.: 7, 13, 14, 15, 17 & 18

# REPAIR DIAGRAMS

# FUEL TANKER

## DROP ELBOW REPAIR - PARTS LIST FOR 918 & 919 ELBOWS

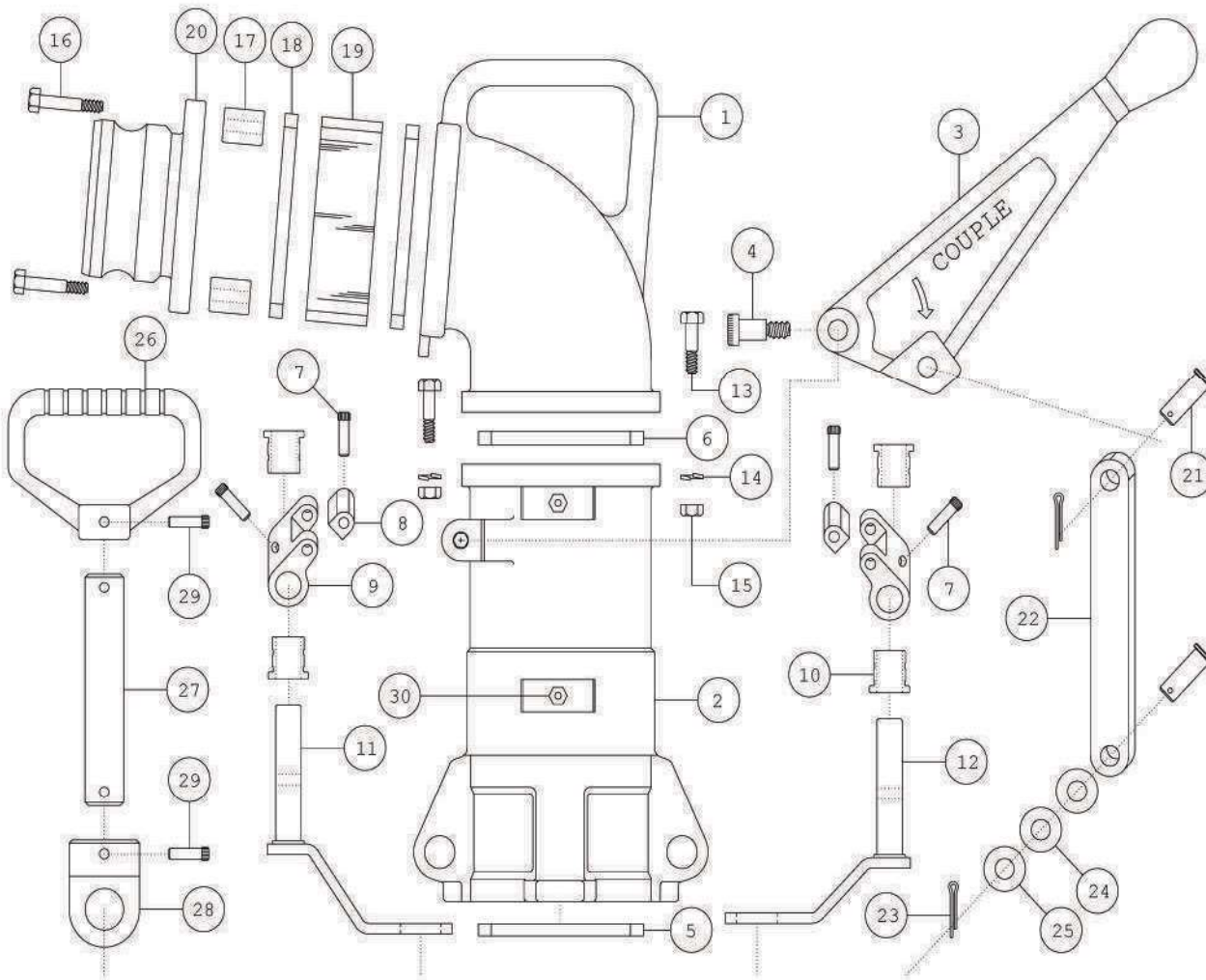

COUPLINGS + 

| Ref. No. | Description         | Material    | Part # | Qty    | Ref. No. | Description              | Material             | Part #   | Qty    |
|----------|---------------------|-------------|--------|--------|----------|--------------------------|----------------------|----------|--------|
| 1        | Upper Body          | Aluminum    | 29090  | 1      | 18       | Gasket                   | Buna-N               | 903G     | 2      |
| 2        | Lower Body          | Aluminum    | 29019  | 1      | 19       | Sight Glass              | Acrylic              | 900SG    | 1      |
| 3        | Handle              | Aluminum    | 29193  | 1      | 20       | Inlet Adapter-3A         | Aluminum             | AF-300AL | 1      |
| 4        | Shoulder screw      | Steel Black | 11210  | 1      | ---      | Inlet Adapter-4A         | Aluminum             | AF-400AL | option |
| 5        | Gasket Fill Adapter | Buna-N      | 901G   | 1      | ---      | Inlet Coupler-3B         | Aluminum             | BF-300AL | option |
| ---      | Gasket Fill Adapter | Viton       | 901G-V | option | ---      | Inlet Coupler-4B         | Aluminum             | BF-400AL | option |
| 6        | Gasket Connect      | Buna-N      | 902G   | 1      | ---      | Inlet Male Thread-3" NPT | Aluminum             | MTF300AL | option |
| 7        | Pin                 | Stainless   | 76325  | 4      | ---      | Inlet Male Thread-4" NPT | Aluminum             | MTF400AL | option |
| 8        | Cam                 | Stainless   | 79008  | 2      | 21       | Clevis Pin               | Stainless            | 71232    | 2      |
| 9        | Cam Arm             | Stainless   | 79009  | 2      | 22       | Flat Linkage             | Stainless            | 791911   | 1      |
| 10       | Sleeve              | Brass       | 31620  | 4      | 23       | Cotter Pin               | Stainless            | 72520    | 2      |
| 11       | Left Linkage Arm    | Stainless   | 92211  | 1      | 24       | Waved Washer             | Stainless            | 71204    | 1      |
| 12       | Right Linkage Arm   | Stainless   | 92212  | 1      | 25       | Flat Washer              | Stainless            | 71203    | 2      |
| 13       | Bolt                | Stainless   | 77938  | 4      | 26       | "D" Handle               | Aluminum             | 291802   | 1      |
| 14       | Spring Washer       | Stainless   | 77902  | 4      | 27       | Rod                      | Steele Nickle        | 191803   | 1      |
| 15       | Hex Nut             | Stainless   | 77906  | 4      | 28       | Connector                | Stainless            | 791804   | 1      |
| 16       | Bolt                | Stainless   | 77954  | 4      | 29       | Pin                      | Stainless            | 76332    | 2      |
| 17       | Space Holder        | Aluminum    | 21925  | 4      | 30       | Grease Fitting           | Brass Nickle         | 30505    | 2      |
|          |                     |             |        |        | 31       | Sight Glass Repair Kit   | Includes 16,17,18,19 | 918SGK   | 1      |



# DRY DISCONNECT

# COUPLERS

## COUPLER X FEMALE NPT

COUPLINGS +



- Not to be used as a shut off valve.
- Coupler with self-locking handles
- Working Pressure:  
1-1/2" & 2" at 150 psi  
3 at 125 psi

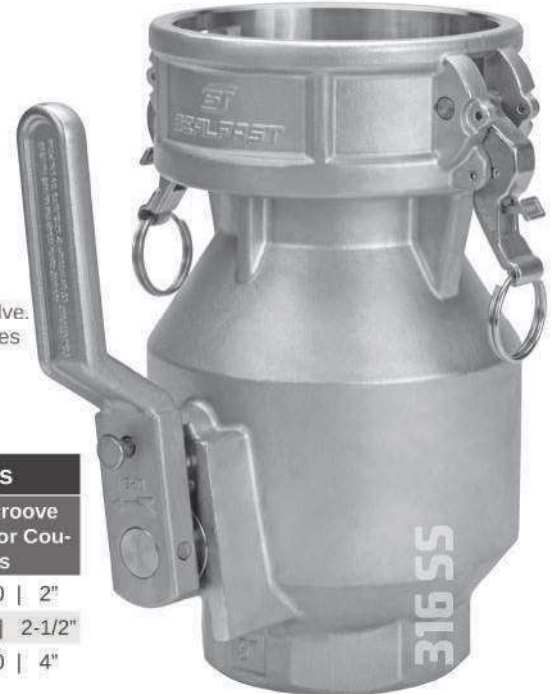

### Size Considerations

| Dry-Disconnect Adapters or Couplers | Cam & Groove Adapters or Couplers |
|-------------------------------------|-----------------------------------|
| 762D-150   2"                       | 772D-150   2"                     |
| 762D-200   2-1/2"                   | 772D-200   2-1/2"                 |
| 762D-300   4"                       | 772D-300   4"                     |

### Coupler x Female NPT

| SIZES  | ALUMINUM VITON* |      | 316 SS VITON* |      |
|--------|-----------------|------|---------------|------|
|        | Part #          | List | Part #        | List |
| 2"     | 762D-150        |      | 772D-150      |      |
| 2-1/2" | 762D-200        |      | 772D-200      |      |
| 4"     | 762D-300        |      | 772D-300      |      |

### Coupler x Female NPT

| SIZES  | ALUMINUM PTFE* |      | 316 SS PTFE* |      |
|--------|----------------|------|--------------|------|
|        | Part #         | List | Part #       | List |
| 2"     | 763D-150       |      | 773D-150     |      |
| 2-1/2" | 763D-200       |      | 773D-200     |      |
| 4"     | 763D-300       |      | 773D-300     |      |

## REPAIR KITS



| SIZES  | VITON*   |      |
|--------|----------|------|
|        | Part #   | List |
| 2"     | RK 150DT |      |
| 2-1/2" | RK 200DT |      |
| 4"     | RK 300DT |      |



| SIZES  | PTFE ENCAPSULATED |      |
|--------|-------------------|------|
|        | Part #            | List |
| 2"     | RK 150DV          |      |
| 2-1/2" | RK 200DV          |      |
| 4"     | RK 300DV          |      |

\*VITON is a registered trademark of DuPont Dow Elastomer

# ADAPTERS

# DRY DISCONNECT

## ADAPTER X FEMALE NPT

- Working pressure:
- 1-1/2" and 2" at 150 psi
  - 3" at 125 psi

### Size Considerations

| SIZES  | Dry - Disconnect Adapter or Coupler | Cam & Groove Adapter or Coupler |
|--------|-------------------------------------|---------------------------------|
| 1-1/2" | 1-1/2"                              | 2"                              |
| 2"     | 2"                                  | 2-1/2"                          |
| 3"     | 3"                                  | 4"                              |



### WARNING:

\*\*S.F.I. Can not be held responsible for the integrity of field rebuilt products. It is strongly recommended that the procedures outlined in the instructions, supplied with the part, be followed and the part be leak tested before placing it back in service. Instructions also on request.



### Adapter x Female NPT

| SIZES  | ALUMINUM VITON* |      | 316 SS VITON* |      |
|--------|-----------------|------|---------------|------|
|        | Part #          | List | Part #        | List |
| 1-1/2" | 622A-150        |      | 672A-150      |      |
| 2"     | 622A-200        |      | 672A-200      |      |
| 3"     | 622A-300        |      | 672A-300      |      |

\*VITON is a registered trademark of DuPont Dow Elastomer

### Adapter x Female NPT

| SIZES  | ALUMINUM PTFE* |      | 316 SS PTFE* |      |
|--------|----------------|------|--------------|------|
|        | Part #         | List | Part #       | List |
| 1-1/2" | 623A-150       |      | 673A-150     |      |
| 2"     | 623A-200       |      | 673A-200     |      |
| 3"     | 623A-300       |      | 673A-300     |      |

## REPAIR KITS & SECURITY CHAINS

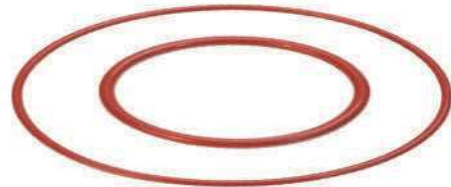
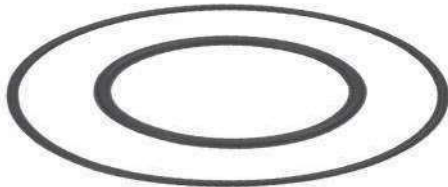

| SIZES  | VITON*   |      |
|--------|----------|------|
|        | Part #   | List |
| 1-1/2" | RK 150AV |      |
| 2"     | RK 200AV |      |
| 3"     | RK 300AV |      |

\*VITON is a registered trademark of DuPont Dow Elastomer

| SIZES  | PTFE     |      |
|--------|----------|------|
|        | Part #   | List |
| 1-1/2" | RK 150AT |      |
| 2"     | RK 200AT |      |
| 3"     | RK 300AT |      |

|                                       | Part #   | List |
|---------------------------------------|----------|------|
| Steel 6" Security Chain w/Safety Clip | SC 600   |      |
| SS 6" Security Chain w/Safety Clip    | SC 600SS |      |





# DRY DISCONNECT

# REPAIR DIAGRAMS

## COUPLER - PARTS LIST

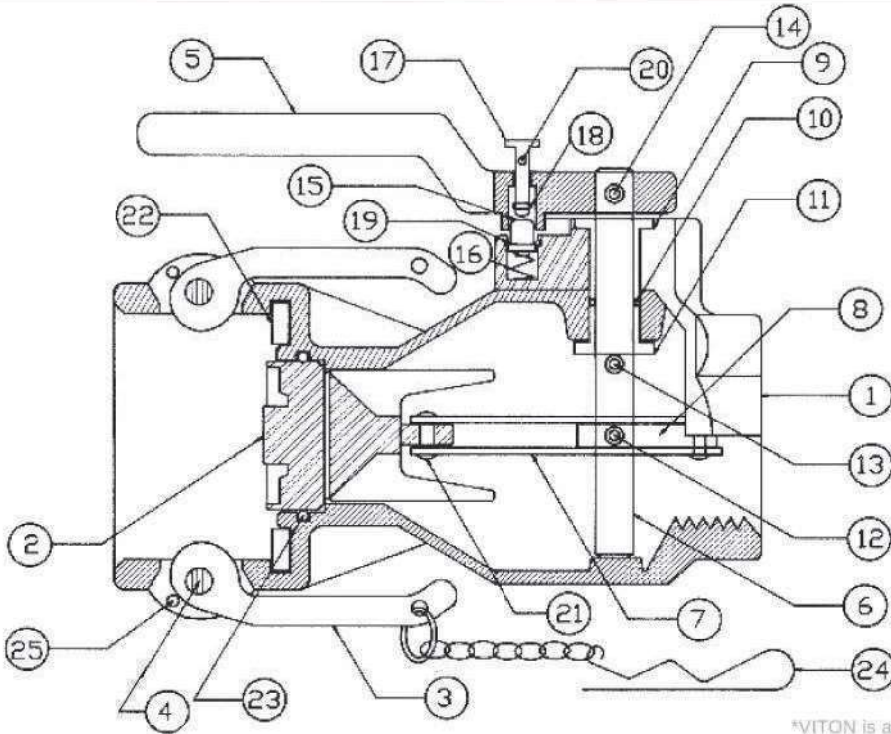

- \*REPAIR KIT:  
(All Coupler repair kits include a punch)
- \*\*LOCK REPAIR KIT:
- Part# RK1000 - 1-1/2" & 2" & Part# RK1001 - 3" includes:  
Stud, Spring, Button, C-Ring & Hex Nut.

\*VITON is a registered trademark of DuPont Dow Elastomer

### PARTS LIST

| Ref. No. | Description  | Material             | Qty | 1-1/2" Coupler | 2" Coupler | 3" Coupler |
|----------|--------------|----------------------|-----|----------------|------------|------------|
| 1        | BODY         | ALUMINUM A356/T6     | 1   | 71501AL        | 72001AL    | 73001AL    |
| ---      | ---          | SS                   | --- | 71501SS        | 72001SS    | 73001SS    |
| 2        | POPPET       | ALUMINUM A356/T6     | 1   | 71502AL        | 72002AL    | 73002AL    |
| ---      | ---          | SS                   | --- | 71502SS        | 72002SS    | 73002SS    |
| 3        | CAM ARM      | SS                   | 2   | H200SK         | H200SK     | H300SK     |
| 4        | CAM PIN      | SS                   | 2   | P200SS         | P200SS     | P300SS     |
| *5       | HANDLE       | SS                   | --- | H1205SS        | H1205SS    | H3405SS    |
| *6       | SHAFT        | SS                   | 1   | 71206          | 71206      | 73006      |
| *7       | LINK         | SS                   | 2   | 71507          | 72007      | 73007      |
| 8        | CAM          | SS                   | 1   | 71508          | 72008      | 73008      |
| 9        | BUSHING      | SS                   | 1   | 71209          | 71209      | 73009      |
| *10      | O-RING       | *VITON               | --- | R1210V         | R1210V     | R3010V     |
| ---      | ---          | PTFE ENCAP. SILICONE | 1   | R1210T         | R1210T     | R3010T     |
| 11       | RETAINER     | SS                   | 1   | 71211          | 71211      | 73411      |
| *12      | ROLL PIN     | SS                   | 1   | P4022          | P4022      | P6032      |
| *13      | ROLL PIN     | SS                   | 1   | P4022          | P4022      | P6032      |
| 14       | PIN          | SS                   | 1   | P4627          | P4627      | P4636      |
| **15     | STUD         | SS                   | 1   | 71215          | 71215      | 73015      |
| **16     | SPRING       | SS                   | 1   | 71216          | 71216      | 73016      |
| **17     | BUTTON       | SS                   | 1   | 71217          | 71217      | 73017      |
| **18     | C-RING       | SS                   | 1   | 71218          | 71218      | 73018      |
| **19     | HEX NUT      | SS                   | 1   | 71219          | 71219      | 73019      |
| 20       | BUTTON HOLE  |                      | 1   | ---            | ---        | ---        |
| 21       | RIVET        | SS                   | 2   | P4719          | P4719      | P6025      |
| *22      | GASKET       | *VITON               | --- | 200VI          | 250VI      | 400VI      |
| ---      | ---          | TEFLON               | --- | 200TFCAP       | 250TFCAP   | 400TFCAP   |
| *23      | O-RING       | *VITON               | --- | R1523V         | R2023V     | R3023V     |
| ---      | ---          | PTFE ENCAP. SILICONE | --- | R1523T         | R2023T     | R3023T     |
| 24       | SAFETY PIN   | STEEL PLATED         | 1   | C1224ST        | C1224ST    | C3024ST    |
| ---      | SAFETY CHAIN | SS                   | --- | C1224SS        | C1224SS    | C3024SS    |
| 25       | SAFETY PIN   | HOLE                 | 2   | ---            | ---        | ---        |

COUPLINGS +



## ADAPTER - PARTS LIST

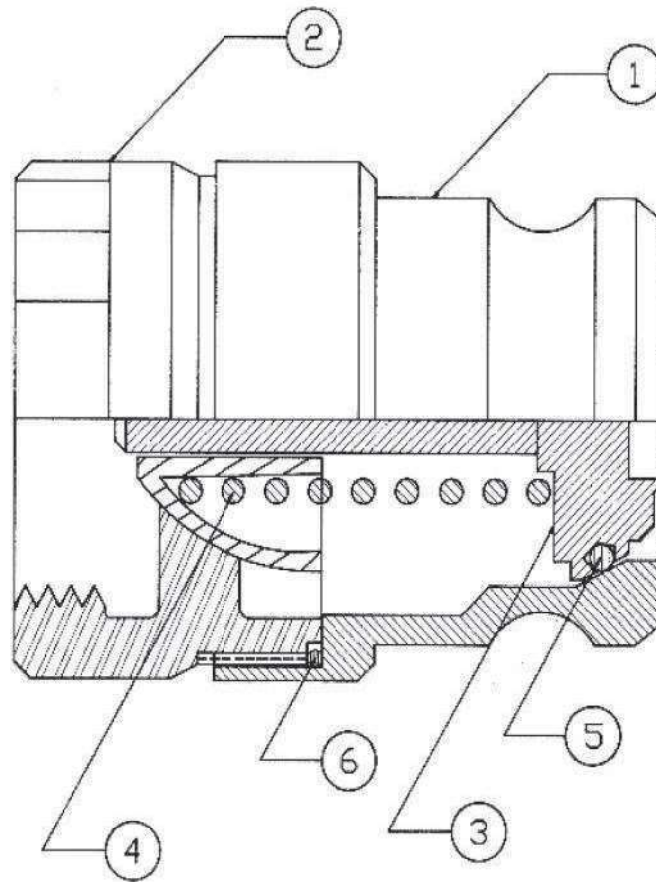

\*VITON is a registered trademark of DuPont Dow Elastomer

### SEAL FAST DRY- DISCONNECT COUPLING - PRODUCT NO.

| Ref. No. | Description | Material             | Qty | 1-1/2" Adaptor | 2" Adaptor | 3" Adaptor |
|----------|-------------|----------------------|-----|----------------|------------|------------|
| 1        | ADAPTER     | ALUMINUM A356/T6     | 1   | 61501AL        | 62001AL    | 63001AL    |
|          |             | SS                   |     | 61501SS        | 62001SS    | 63001SS    |
| 2        | PIPE END    | ALUMINUM A356/T6     | 1   | 61502AL        | 62002AL    | 63002AL    |
|          |             | SS                   |     | 61502SS        | 62002SS    | 63002SS    |
| 3        | DISC ASSY.  | ALUMINUM A356/T6     | 1   | 61503AL        | 62003AL    | 63003AL    |
|          |             | SS                   |     | 61503SS        | 62003SS    | 63003SS    |
| 4        | SPRING      | ALUMINUM A356/T6     | 1   | 61504ST        | 62004ST    | 63004ST    |
|          |             | SS                   |     | 61504SS        | 62004SS    | 63004SS    |
| *5       | O-RING      | *VITON               | 1   | R1505V         | R2005V     | R3005V     |
|          |             | PTFE ENCAP. SILICONE |     | R1505T         | R2005T     | R3005T     |
| *6       | O-RING      | *VITON               | 1   | R1506V         | R2006V     | R3006V     |
|          |             | PTFE ENCAP. SILICONE |     | R1506T         | R2006T     | R3006T     |

\*RECOMMENDED REPAIR KIT

### SEAL FAST DRY- DISCONNECT COUPLING - PRODUCT NO. (ASSEMBLY)

| Material/Seal     | 1-1/2" Adaptor | 1-1/2" Coupler | 2" Adaptor | 2" Coupler | 3" Adaptor | 3" Coupler |
|-------------------|----------------|----------------|------------|------------|------------|------------|
| ALUMINUM/*VITON   | 622A-150       | 762D-150       | 622A-200   | 762D-200   | 622A-300   | 762D-300   |
| ALUMINUM/*TEFLON  | 623A-150       | 763D-150       | 623A-200   | 763D-200   | 623A-300   | 762D-300   |
| STAINLESS/*VITON  | 672A-150       | 772D-150       | 672A-200   | 772D-200   | 672A-300   | 772D-300   |
| STAINLESS/*TEFLON | 673A-150       | 773D-150       | 673A-200   | 773D-200   | 673A-300   | 773D-300   |
| *VITON            | RK-150AV       | RK-150DV       | RK-200AV   | RK-200DV   | RK-300AV   | RK-300DV   |
| *TEFLON           | RK-150AT       | RK-150DT       | RK-200AT   | RK-200DT   | RK-300AT   | RK-300DT   |

\*MARKS COMPONENTS OF REPAIR KIT



# SHANK

# PIN LUG

## ALUMINUM SHANK w/BRASS NUT - NPSH AND NST

▶ **Note:** Working pressures are directly related to the hose and coupling installation.



| Size   | Threads | ALUMINUM     |      |                               |      |             |      |
|--------|---------|--------------|------|-------------------------------|------|-------------|------|
|        |         | Complete Set |      | Female w/Brass Pin Swivel Lug |      | Male Shank  |      |
|        |         | Part #       | List | Part #                        | List | Part #      | List |
| 1-1/2" | NPSH    | AL150S       |      | AL150F                        |      | AL150M      |      |
| 2"     | NPSH    | AL200S       |      | AL200F                        |      | AL200M      |      |
| 2-1/2" | NPSH    | AL250S       |      | AL250F                        |      | AL250M      |      |
| 3"     | NPSH    | AL300S       |      | AL300F                        |      | AL300M      |      |
| 4"     | NPSH    | AL400S       |      | AL400F                        |      | AL400M      |      |
| 6"     | NPSH    | AL600S       |      | AL600F                        |      | AL600M      |      |
| 1-1/2" | NST     | *A 150S-NST  |      | *AL150F-NST                   |      | *AL150M-NST |      |
| 2-1/2" | NST     | *A 250S-NST  |      | *AL250F-NST                   |      | *AL250M-NST |      |

\*NST Threads

## BRASS SHANK- NPSH AND NST

▶ **Note:** Working pressures are directly related to the hose and coupling installation.



| Size   | Threads | BRASS        |      |                         |      |            |      |
|--------|---------|--------------|------|-------------------------|------|------------|------|
|        |         | Complete Set |      | Female w/Pin Swivel Lug |      | Male Shank |      |
|        |         | Part #       | List | Part #                  | List | Part #     | List |
| 1-1/2" | NPSH    | BSS150       |      | BSS150F                 |      | BSS150M    |      |
| 2"     | NPSH    | BSS200       |      | BSS200F                 |      | BSS200M    |      |
| 2-1/2" | NPSH    | BSS250       |      | BSS250F                 |      | BSS250M    |      |
| 3"     | NPSH    | BSS300       |      | BSS300F                 |      | BSS300M    |      |
| 1-1/2" | NST     | *BSS150NH    |      | *BSS150NHF              |      | *BSS150NHM |      |
| 2"     | NST     | *BSS200NH    |      | *BSS200NHF              |      | *BSS200NHM |      |
| 2-1/2" | NST     | *BSS250NH    |      | *BSS250NHF              |      | *BSS250NHM |      |

\*NST Threads



# PIN LUG

# SHANK

## POLYPROPYLENE SHANK - NPSH

► **Note:** Working pressures are directly related to the hose and coupling installation.



COUPLINGS +



| Size   | POLYPROPYLENE |      |                         |      |            |      |
|--------|---------------|------|-------------------------|------|------------|------|
|        | Complete Set  |      | Female w/Pin Swivel Lug |      | Male Shank |      |
|        | Part #        | List | Part #                  | List | Part #     | List |
| 1"     | PP100S        |      | PP100F                  |      | PP100M     |      |
| 1-1/4" | PP125S        |      | PP125F                  |      | PP125M     |      |
| 1-1/2" | PP150S        |      | PP150F                  |      | PP150M     |      |
| 2"     | PP200S        |      | PP200F                  |      | PP200M     |      |
| 3"     | PP300S        |      | PP300F                  |      | PP300M     |      |

## REPLACEMENT GASKETS - SHANK COUPLINGS

| Size   | SBR    |      |
|--------|--------|------|
|        | Part # | List |
| 1/2"   | RW050  |      |
| 3/4"   | RW075  |      |
| 1"     | RW100  |      |
| 1-1/4" | RW125  |      |
| 1-1/2" | RW150  |      |
| 2"     | RW200  |      |
| 2-1/2" | RW250  |      |
| 3"     | RW300  |      |
| 4"     | RW400  |      |
| 5"     | ---    | ---  |
| 6"     | RW600  |      |

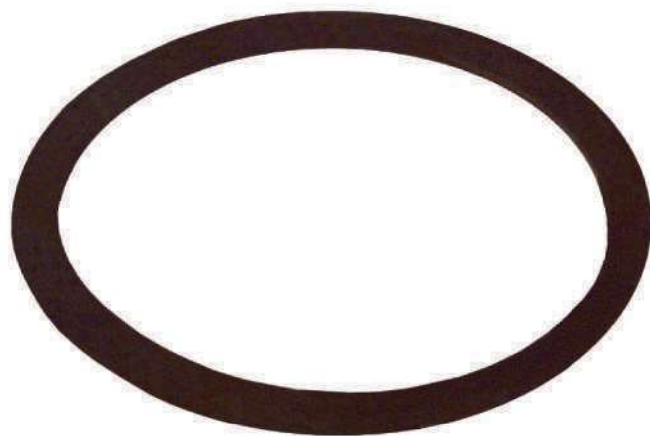

## SPANNER WRENCH

| Size   | PLATED IRON |      |
|--------|-------------|------|
|        | Part #      | List |
| 1-1/2" | SP 150      |      |
| 2"     | SP 200      |      |
| 2-1/2" | SP 250      |      |
| 3"     | SP 300      |      |
| 4"     | SP 400      |      |





# SHANK

## LONG SHANK HOSE NIPPLE - HEX SWIVEL w/NPSH THREADS



COUPLINGS +



\*\*IRON\*STEEL

| Size     | *ZINC PLATED STEEL & **ZINC PLATED IRON |      |          |      |          |      |
|----------|---|------|----------|------|----------|------|
|          | Complete Set                            |      | Female   |      | Male     |      |
|          | Part #                                  | List | Part #   | List | Part #   | List |
| *1/2"    | SLS050                                  |      | SLS050F  |      | SLS050M  |      |
| *3/4"    | SLS075                                  |      | SLS075F  |      | SLS075M  |      |
| *1"      | SLS100                                  |      | SLS100F  |      | SLS100M  |      |
| **1-1/4" | SLS125C                                 |      | SLS125CF |      | SLS125CM |      |
| **1-1/2" | SLS150C                                 |      | SLS150CF |      | SLS150CM |      |
| **2"     | SLS200C                                 |      | SLS200CF |      | SLS200CM |      |

## LONG SHANK HOSE NIPPLE - HEX SWIVEL w/NPSH THREADS



| Size<br>Hose x Thread | BRASS        |      |               |      |               |      |
|-----------------------|--------------|------|---------------|------|---------------|------|
|                       | Complete Set |      | Female        |      | Male          |      |
|                       | Part #       | List | Part #        | List | Part #        | List |
| 1/2" x 3/4" NPSH      | BLS050075    |      | BLS050075F    |      | BLS050075M    |      |
| 1/2" x 3/4" GHT       | BLS050075GHT |      | BLS050075GHTF |      | BLS050075GHTM |      |
| 5/8" X 3/4" NPSH      | BLS058075    |      | BLS058075F    |      | BLS058075M    |      |
| 5/8" x 3/4" GHT       | BLS058075GHT |      | BLS058075GHTF |      | BLS058075GHTM |      |
| 3/4" x 3/4" NPSH      | BLS075       |      | BLS075F       |      | BLS075M       |      |
| 3/4" x 3/4" GHT       | BLS075GHT    |      | BLS075GHTF    |      | BLS075GHTM    |      |
| 1" x 1" NPSH          | BLS100       |      | BLS100F       |      | BLS100M       |      |
| 1-1/4" x 1-1/4" NPSH  | BLS125       |      | BLS125F       |      | BLS125M       |      |
| 1-1/2" x 1-1/2" NPSH  | BLS150       |      | BLS150F       |      | BLS150M       |      |
| 1-1/2" x 1-1/2" NST   | BLS150NH     |      | BLS150NHF     |      | BLS150NHM     |      |
| 2" x 2" NPSH          | BLS200       |      | BLS200F       |      | BLS200M       |      |
| 2-1/2" x 2-1/2" NPSH  | BLS250       |      | BLS250F       |      | BLS250M       |      |
| 2-1/2" x 2-1/2" NST   | BLS250NH     |      | BLS250NHF     |      | BLS250NHM     |      |
| 3" x 3" NPSH          | BLS300       |      | BLS300F       |      | BLS300M       |      |

## HOSE MENDERS



| Size  | BRASS  |      |
|-------|--------|------|
|       | Part # | List |
| 1/8"  | HM-2   |      |
| 3/16" | HM-3   |      |
| 1/4"  | HM-4   |      |
| 5/16" | HM-5   |      |
| 3/8"  | HM-6   |      |
| 1/2"  | HM-8   |      |
| 5/8"  | HM-10  |      |
| 3/4"  | HM-12  |      |

## SHORT SHANK HOSE NIPPLE



| Size<br>Hose x Thread | BRASS        |      |               |      |               |      |
|-----------------------|--------------|------|---------------|------|---------------|------|
|                       | Complete Set |      | Male          |      | Female        |      |
|                       | Part #       | List | Part #        | List | Part #        | List |
| 3/8" x 3/4" NPSH      | BSS038075    |      | BSS038075F    |      | BSS038075M    |      |
| 3/8" x 3/4" GHT       | BSS038075GHT |      | BSS038075GHTF |      | BSS038075GHTM |      |
| 1/2" x 3/4" NPSH      | BSS050075    |      | BSS050075F    |      | BSS050075M    |      |
| 1/2" x 3/4" GHT       | BSS050075GHT |      | BSS050075GHTF |      | BSS050075GHTM |      |
| 5/8" x 3/4" NPSH      | BSS058075    |      | BSS058075F    |      | BSS058075M    |      |
| 5/8" x 3/4" GHT       | BSS058075GHT |      | BSS058075GHTF |      | BSS058075GHTM |      |
| 3/4" x 3/4" NPSH      | BSS075       |      | BSS075F       |      | BSS075M       |      |
| 3/4" x 3/4" GHT       | BSS075GHT    |      | BSS075GHTF    |      | BSS075GHTM    |      |
| 1" x 1" NPSH          | BSS100       |      | BSS100F       |      | BSS100M       |      |
| 1-1/4" x 1-1/4" NPSH  | BSS125       |      | BSS125F       |      | BSS125M       |      |



## HOSE NIPPLE - MALE NPT x HOSE BARB



| Size<br>Thread X Hose | Zinc Plated Steel |      | 316 SS     |      |
|-----------------------|-------------------|------|------------|------|
|                       | Part #            | List | Part #     | List |
| 1/8" x 1/4"           | HN018025          |      | HNSS018025 |      |
| 1/4" x 1/4"           | HN025025          |      | HNSS025025 |      |
| 1/4" x 3/8"           | HN025038          |      | HNSS025038 |      |
| 1/4" x 1/2"           | HN025050          |      | HNSS025050 |      |
| 3/8" x 1/4"           | HN038025          |      | HNSS038025 |      |
| 3/8" x 3/8"           | HN038038          |      | HNSS038038 |      |
| 3/8" x 1/2"           | HN038050          |      | HNSS038050 |      |
| 1/2" x 3/8"           | HN050038          |      | HNSS050038 |      |
| 1/2" x 1/2"           | HN050050          |      | HNSS050050 |      |
| 1/2" x 3/4"           | HN050075          |      | HNSS050075 |      |
| 3/4" x 1/2"           | HN075050          |      | HNSS075050 |      |
| 3/4" x 3/4"           | HN075075          |      | HNSS075075 |      |
| 3/4" x 1"             | HN075100          |      | HNSS075100 |      |
| 1" x 3/4"             | HN100075          |      | HNSS100075 |      |
| 1" x 1"               | HN100100          |      | HNSS100100 |      |



# BAUER TYPE

## HOSE SHANK FEMALE X HOSE SHANK MALE

▶ **\*NOT** Recommended for Chemicals or Hazardous Type Materials

– WORKING PRESSURES UP TO 150 PSI - SEE WARNING BELOW –

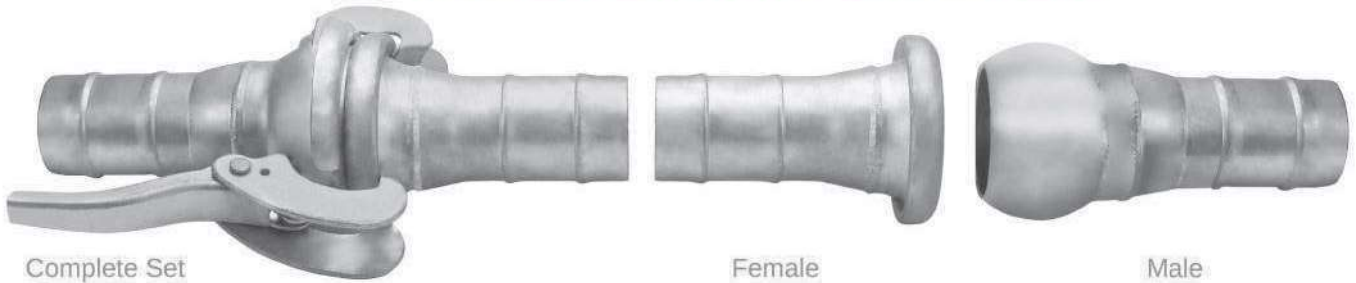

Complete Set

Female

Male

| Size | ZINC PLATED STEEL |      |                     |      |                   |      |
|------|-------------------|------|---------------------|------|-------------------|------|
|      | Complete Set      |      | Female w/Hose Shank |      | Male w/Hose Shank |      |
|      | Part #            | List | Part #              | List | Part #            | List |
| 2"   | BTC200            |      | BTC200F             |      | BTC200M           |      |
| 3"   | BTC300            |      | BTC300F             |      | BTC300M           |      |
| 4"   | BTC400            |      | BTC400F             |      | BTC400M           |      |
| 6"   | BTC600            |      | BTC600F             |      | BTC600M           |      |
| 8"   | BTC800            |      | BTC800F             |      | BTC800M           |      |
| *10" | BTC1000           |      | BTC1000F            |      | BTC1000M          |      |
| *12" | BTC1200           |      | BTC1200F            |      | BTC1200M          |      |

\*10" & 12" is type A w/lever permanently attached to female end

## PARTS



| Size | ZINC PLATED STEEL |      | BUNA-N        |      | STEEL        |      |
|------|-------------------|------|---------------|------|--------------|------|
|      | Lever Ring        |      | Rubber O-Ring |      | Safety Clips |      |
|      | Part #            | List | Part #        | List | Part #       | List |
| 2"   | BTC200LR          |      | BTC200G       |      | SP2030       |      |
| 3"   | BTC300LR          |      | BTC30G        |      | SP2030       |      |
| 4"   | BTC400LR          |      | BTC400G       |      | SP400        |      |
| 6"   | BTC600LR          |      | BTC600G       |      | SP6080       |      |
| 8"   | BTC800LR          |      | BTC800G       |      | SP6080       |      |
| *10" | ---               |      | BTC1000G      |      | ---          |      |
| *12" | ---               |      | BTC1200G      |      | ---          |      |

## WARNING:

Working pressure may vary depending on how the couplings are attached to the hose assembly. Before operation, always check the hose assembly for proper attachment and that couplings are in working order.



# BAUER TYPE

## CRIMP HOSE SHANK FEMALE X CRIMP HOSE SHANK MALE

▶ \*NOT Recommended for Chemicals or Hazardous Type Materials



Complete Set



Female



Male

COUPLINGS +



| Size | ZINC PLATED STEEL |      |                     |      |                   |      |
|------|-------------------|------|---------------------|------|-------------------|------|
|      | Complete Set      |      | Female w/Hose Shank |      | Male w/Hose Shank |      |
|      | Part #            | List | Part #              | List | Part #            | List |
| 2"   | BTC200C           |      | BTC200FC            |      | BTC200MC          |      |
| 3"   | BTC300C           |      | BTC300FC            |      | BTC300MC          |      |
| 4"   | BTC400C           |      | BTC400FC            |      | BTC400MC          |      |
| 6"   | BTC600C           |      | BTC600FC            |      | BTC600MC          |      |
| 8"   | BTC800C           |      | BTC800FC            |      | BTC800MC          |      |

## PARTS



| Size | ZINC PLATED STEEL |      | BUNA-N        |      | STEEL        |      |
|------|-------------------|------|---------------|------|--------------|------|
|      | Lever Ring        |      | Rubber O-Ring |      | Safety Clips |      |
|      | Part #            | List | Part #        | List | Part #       | List |
| 2"   | BTC200LR          |      | BTC200G       |      | SP2030       |      |
| 3"   | BTC300LR          |      | BTC30G        |      | SP2030       |      |
| 4"   | BTC400LR          |      | BTC400G       |      | SP400        |      |
| 6"   | BTC600LR          |      | BTC600G       |      | SP6080       |      |
| 8"   | BTC800LR          |      | BTC800G       |      | SP6080       |      |
| *10" | ---               |      | BTC1000G      |      | ---          |      |
| *12" | ---               |      | BTC1200G      |      | ---          |      |

## WARNING:

Working pressure may vary depending on how the couplings are attached to the hose assembly. Before operation, always check the hose assembly for proper attachment and that couplings are in working order.





# BAUER TYPE

## FLANGED FEMALE X MALE

▶\*NOT Recommended for Chemicals or Hazardous Type Materials

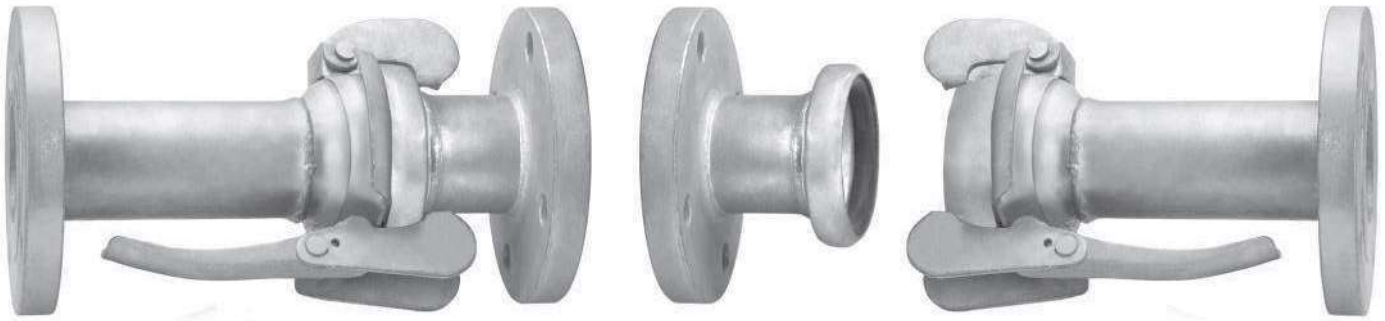

Complete Set

Female

Male

| Size | ZINC PLATED STEEL |      |                 |      |               |      |
|------|-------------------|------|-----------------|------|---------------|------|
|      | Complete Set      |      | Female w/Flange |      | Male w/Flange |      |
|      | Part #            | List | Part #          | List | Part #        | List |
| 2"   | BTC200FL          |      | BTC200FLF       |      | BTC200FLM     |      |
| 3"   | BTC300FL          |      | BTC300FLF       |      | BTC300FLM     |      |
| 4"   | BTC400FL          |      | BTC400FLF       |      | BTC400FLM     |      |
| 6"   | BTC600FL          |      | BTC600FLF       |      | BTC600FLM     |      |
| 8"   | BTC800FL          |      | BTC800FLF       |      | BTC800FLM     |      |

## MALE THREADED FEMALE X MALE

▶\*NOT Recommended for Chemicals or Hazardous Type Materials

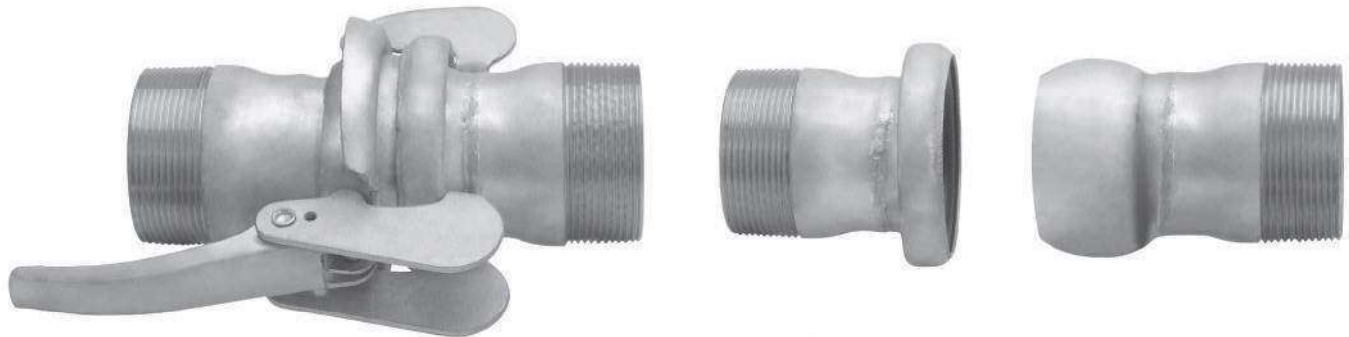

Complete Set

Female

Male

| Size | ZINC PLATED STEEL |      |                     |      |                   |      |
|------|-------------------|------|---------------------|------|-------------------|------|
|      | Complete Set      |      | Female w/Hose Shank |      | Male w/Hose Shank |      |
|      | Part #            | List | Part #              | List | Part #            | List |
| 2"   | BTC200MT          |      | BTC200MTM           |      | BTC200MTF         |      |
| 3"   | BTC300MT          |      | BTC300MTM           |      | BTC300MTF         |      |
| 4"   | BTC400MT          |      | BTC400MTM           |      | BTC400MTF         |      |
| 6"   | BTC600MT          |      | BTC600MTM           |      | BTC600MTF         |      |
| 8"   | BTC800MT          |      | BTC800MTM           |      | BTC800MTF         |      |

### WARNING:

Working pressure may vary depending on how the couplings are attached to the hose assembly. Before operation, always check the hose assembly for proper attachment and that couplings are in working order.

# RING LOCK

## HOSE SHANK FEMALE X MALE

▶ **\*NOT** Recommended for Chemicals or Hazardous Type Materials



Complete Set



Female



Male

COUPLINGS +



| Size | ZINC PLATED STEEL |      |                     |      |                   |      |
|------|-------------------|------|---------------------|------|-------------------|------|
|      | Complete Set      |      | Female w/Hose Shank |      | Male w/Hose Shank |      |
|      | Part #            | List | Part #              | List | Part #            | List |
| 3"   | RLC300            |      | RLC200F             |      | RLC200M           |      |
| 4"   | RLC400            |      | RLC300F             |      | RLC300M           |      |
| 6"   | RLC600            |      | RLC600F             |      | RLC600M           |      |
| 8"   | RLC800            |      | RLC800F             |      | RLC800M           |      |

## PARTS



| Size | ZINC PLATED STEEL |      |
|------|-------------------|------|
|      | Lever Ring        |      |
|      | Part #            | List |
| 3"   | RLC300LR          |      |
| 4"   | RLC400LR          |      |
| 6"   | RLC600LR          |      |
| 8"   | RLC800LR          |      |

| Size | BUNA-N        |      |
|------|---------------|------|
|      | Rubber O-Ring |      |
|      | Part #        | List |
| 3"   | RLC300G       |      |
| 4"   | RLC400G       |      |
| 6"   | RLC600G       |      |
| 8"   | RLC800G       |      |

### WARNING:

Working pressure may vary depending on how the couplings are attached to the hose assembly. Before operation, always check the hose assembly for proper attachment and that couplings are in working order.



# SANDBLAST

## HOSE ENDS & NOZZLE HOLDERS

COUPLINGS +



### Hose Ends w/Crowfoot

| Hose Size | Hose O.D. | ALUMINUM |                 |      | BRASS  |                 |      |
|-----------|-----------|----------|-----------------|------|--------|-----------------|------|
|           |           | Part #   | Screws Supplied | List | Part # | Screws Supplied | List |
| 3/4"      | 1-1/2"    | Q 1AL    | 4               |      | Q 1BR  | 4               |      |
| 1"        | 1-7/8"    | Q 2AL    | 4               |      | Q 2BR  | 4               |      |
| 1-1/4"    | 2-5/32"   | Q 3AL    | 8               |      | Q 3BR  | 8               |      |
| 1-1/2"    | 2-3/8"    | Q 4AL    | 8               |      | Q 4BR  | 8               |      |

### Hose Ends w/Crowfoot

| Hose Size | Hose O.D. | NYGLASS |                 |      | ZINC PLATED IRON |                 |      |
|-----------|-----------|---------|-----------------|------|------------------|-----------------|------|
|           |           | Part #  | Screws Supplied | List | Part #           | Screws Supplied | List |
| 3/4"      | 1-1/2"    | Q 1NG   | 4               |      | Q 1CI            | 4               |      |
| 1"        | 1-7/8"    | Q 2NG   | 4               |      | Q 2CI            | 4               |      |
| 1-1/4"    | 2-5/32"   | Q 3NG   | 8               |      | Q 3CI            | 8               |      |
| 1-1/2"    | 2-3/8"    | Q 4NG   | 8               |      | Q 4CI            | 8               |      |

### Hose Ends Nozzle Holder - NPSM Threaded

| Hose Size | Hose O.D. | Pipe Thd. | ALUMINUM |                 |      | BRASS  |                 |      |
|-----------|-----------|-----------|----------|-----------------|------|--------|-----------------|------|
|           |           |           | Part #   | Screws Supplied | List | Part # | Screws Supplied | List |
| 3/4"      | 1-1/2"    | 1-1/4"    | HE 1AL   | 4               |      | HE 1BR | 4               |      |
| 1"        | 1-7/8"    | 1-1/4"    | HE 2AL   | 4               |      | HE 2BR | 4               |      |
| 1-1/4"    | 2-5/32"   | 1-1/4"    | HE 3AL   | 8               |      | HE 3BR | 8               |      |
| 1-1/2"    | 2-3/8"    | 1-1/4"    | HE 4AL   | 8               |      | HE 4BR | 8               |      |

### Hose Ends Nozzle Holder - NPSM Threaded

| Hose Size | Hose O.D. | Pipe Thd. | NYGLASS |                 |      | ZINC PLATED IRON |                 |      |
|-----------|-----------|-----------|---------|-----------------|------|------------------|-----------------|------|
|           |           |           | Part #  | Screws Supplied | List | Part #           | Screws Supplied | List |
| 3/4"      | 1-1/2"    | 1-1/4"    | HE 1NG  | 4               |      | HE 1CI           | 4               |      |
| 1"        | 1-7/8"    | 1-1/4"    | HE 2NG  | 4               |      | HE 2CI           | 4               |      |
| 1-1/4"    | 2-5/32"   | 1-1/4"    | HE 3NG  | 8               |      | HE 3CI           | 8               |      |
| 1-1/2"    | 2-3/8"    | 1-1/4"    | HE 4NG  | 8               |      | HE 4CI           | 8               |      |

### Crowfoot X Female NPT

| Pipe Thd. | ALUMINUM |      | BRASS  |      | ZINC PLATED IRON |      |
|-----------|----------|------|--------|------|------------------|------|
|           | Part #   | List | Part # | List | Part #           | List |
| 1-1/4"    | SB 1AL   |      | SB 1BR |      | SB 1CI           |      |
| 1-1/2"    | SB 2AL   |      | SB 2BR |      | SB 2CI           |      |

Gaskets - Fit All Sizes - 25 per Pkg. QG

## REPLACEMENT - GASKETS | SCREWS | WASHERS



### Gaskets & Screws

| Details   |  | Part # | List |
|---|--|--------|------|
| SBR Gaskets - Fit All Sizes - 25 per Pkg.                 |  | QG     |      |
| Phillips Head Screws 100 per Package 10 X 5/8 Zinc plated |  | Screws |      |

### Washers / For Use with Crowfeet only. Not to be used for Sandblast. (50 per pkg)

| 2 Lug             | List | 4 Lug | List |
|-------------------|------|-------|------|
| UCG2              |      | UCG4  |      |
| RED UCG2EP (EPDM) |      | ---   |      |



## HOSE ENDS

► Air & Water ONLY! (Not for Steam Service)

| 150 psi working pressure @ 70° when used w/Universal Clamps |                  |      |         |      |          |      |          |      |
|---|------------------|------|---------|------|----------|------|----------|------|
| Size  | ZINC PLATED IRON |      | BRASS   |      | NYGLASS  |      | 316 SS   |      |
|   | Part #           | List | Part #  | List | Part #   | List | Part #   | List |
| 1/4"  | ---              |      | ---     |      | ---      |      | ---      |      |
| 3/8"  | SFH038           |      | ---     |      | ---      |      | ---      |      |
| 1/2"  | SFH050           |      | SFH050B |      | SFH050NY |      | SFH050SS |      |
| 3/4"  | SFH075           |      | SFH075B |      | SFH075NY |      | SFH075SS |      |
| 1"  | SFH100           |      | SFH100B |      | SFH100NY |      | SFH100SS |      |

\*Use Safety Clips on p. 127 w/All Universal Crowfeet Couplings



## FEMALE NPT

(Air & Water ONLY! Not for Steam Service)

| 150 psi working pressure @ 70° when used w/Universal Clamps |                  |      |         |      |          |      |          |      |
|---|------------------|------|---------|------|----------|------|----------|------|
| Size  | ZINC PLATED IRON |      | BRASS   |      | NYGLASS  |      | 316 SS   |      |
|   | Part #           | List | Part #  | List | Part #   | List | Part #   | List |
| 1/4"  | SFF025           |      | ---     |      | ---      |      | ---      |      |
| 3/8"  | SFF038           |      | ---     |      | ---      |      | ---      |      |
| 1/2"  | SFF050           |      | SFF050B |      | SFF050NY |      | SFF050SS |      |
| 3/4"  | SFF075           |      | SFF075B |      | SFF075NY |      | SFF075SS |      |
| 1"  | SFF100           |      | SFF100B |      | SFF100NY |      | SFF100SS |      |

\*Use Safety Clips on p. 127 w/All Universal Crowfeet Couplings



## MALE NPT

(Air & Water ONLY! Not for Steam Service)

| 150 psi working pressure @ 70° when used w/Universal Clamps |                  |      |         |      |          |      |          |      |
|---|------------------|------|---------|------|----------|------|----------|------|
| Size  | ZINC PLATED IRON |      | BRASS   |      | NYGLASS  |      | 316 SS   |      |
|   | Part #           | List | Part #  | List | Part #   | List | Part #   | List |
| 1/4"  | SFM025           |      | ---     |      | ---      |      | ---      |      |
| 3/8"  | SFM038           |      | ---     |      | ---      |      | ---      |      |
| 1/2"  | SFM050           |      | SFM050B |      | SFM050NY |      | SFM050SS |      |
| 3/4"  | SFM075           |      | SFM075B |      | SFM075NY |      | SFM075SS |      |
| 1"  | SFM100           |      | SFM100B |      | SFM100NY |      | SFM100SS |      |

\*Use Safety Clips on p. 127 w/All Universal Crowfeet Couplings



## TRIPLE CONNECTION

150 psi working pressure @ 70° when used w/Universal Clamps

| Size | ZINC PLATED IRON |      | 316 SS   |      |
|------|------------------|------|----------|------|
|      | Part #           | List | Part #   | List |
| ---  | SFTW00           |      | SFTW00SS |      |



\*Use Safety Clips on p. 127 w/All Universal Crowfeet Couplings

## BLANK END

150 psi working pressure @ 70° when used w/Universal Clamps

| Size | ZINC PLATED IRON |      | 316 SS   |      |
|------|------------------|------|----------|------|
|      | Part #           | List | Part #   | List |
| ---  | SFBE00           |      | SFBE00SS |      |



\*Use Safety Clips on p. 127 w/All Universal Crowfeet Couplings

## FOUR LUG - HOSE ENDS

150 psi working pressure @ 70° when used w/Universal Clamps

| Size   | ZINC PLATED IRON |      |
|--------|------------------|------|
|        | Part #           | List |
| 1-1/4" | SFH125           |      |
| 1-1/2" | SFH150           |      |
| 2"     | SFH200           |      |



\*Use Safety Clips on p. 127 w/All Universal Crowfeet Couplings

## FOUR LUG - FEMALE NPT

150 psi working pressure @ 70° when used w/Universal Clamps

| Size   | ZINC PLATED IRON |      |
|--------|------------------|------|
|        | Part #           | List |
| 1-1/4" | SFF125           |      |
| 1-1/2" | SFF150           |      |
| 2"     | SFF200           |      |



\*Use Safety Clips on p. 127 w/All Universal Crowfeet Couplings



# GROUND JOINT

## GROUND JOINTS

► For Steam Service up to 450°F



PTFE is standard



PTFE is standard



COUPLINGS +



### ZINC PLATED IRON

| Hose Size   | Hose Stem w/Wing Nut & Female Spud |      | Hose Stem   |      | Swivel Nut  |      | Female Spud - Wing Nut Thread x Female NPT |      | Male Pipe Stem - NPT |      |
|-------------|------------------------------------|------|-------------|------|-------------|------|--|------|----------------------|------|
|             | Part #                             | List | Part #      | List | Part #      | List | Part #                                     | List | Part #               | List |
| 1/4"        | SFGJ025                            |      | SFGJ025H    |      | SFGJ025N    |      | SFGJ025S                                   |      | SFGJ025MS            |      |
| 3/8"        | SFGJ038                            |      | SFGJ038H    |      | SFGJ038N    |      | SFGJ038S                                   |      | SFGJ038MS            |      |
| 1/2"        | SFGJ050                            |      | SFGJ050H    |      | SFGJ050N    |      | SFGJ050S                                   |      | SFGJ050MS            |      |
| 1/2" - 3/4" | SFGJ050075                         |      | SFGJ050075H |      | SFGJ050075N |      | SFGJ050075S                                |      | SFGJ050075MS         |      |
| 3/4"        | SFGJ075                            |      | SFGJ075H    |      | SFGJ075N    |      | SFGJ075S                                   |      | SFGJ075MS            |      |
| 1"          | SFGJ100                            |      | SFGJ100H    |      | SFGJ100N    |      | SFGJ100S                                   |      | SFGJ100MS            |      |
| 1-1/4"      | SFGJ125                            |      | SFGJ125H    |      | SFGJ125N    |      | SFGJ125S                                   |      | SFGJ125MS            |      |
| 1-1/2"      | SFGJ150                            |      | SFGJ150H    |      | SFGJ150N    |      | SFGJ150S                                   |      | SFGJ150MS            |      |
| 2"          | SFGJ200                            |      | SFGJ200H    |      | SFGJ200N    |      | SFGJ200S                                   |      | SFGJ200MS            |      |
| 2-1/2"      | SFGJ250                            |      | SFGJ250H    |      | SFGJ250N    |      | SFGJ250S                                   |      | SFGJ250MS            |      |
| 3"          | SFGJ300                            |      | SFGJ300H    |      | SFGJ300N    |      | SFGJ300S                                   |      | SFGJ300MS            |      |
| 4"          | SFGJ400                            |      | SFGJ400H    |      | SFGJ400N    |      | SFGJ400S                                   |      | SFGJ400MS            |      |

### MALE SPUD - WING NUT THREAD X MALE NPT



PTFE SEAT MATERIAL

| Size   | Zinc Plated Iron |      |
|--------|------------------|------|
|        | Part #           | List |
| 1/2"   | SFGJ050M         |      |
| 3/4"   | SFGJ075M         |      |
| 1"     | SFGJ100M         |      |
| 1-1/4" | SFGJ125M         |      |
| 1-1/2" | SFGJ150M         |      |
| 2"     | SFGJ200M         |      |
| 2 1/2" | SFGJ250M         |      |
| 3"     | SFGJ300M         |      |
| 4"     | SFGJ400M         |      |

### DOUBLE SPUD - WING NUT THREAD X WING NUT THREAD



PTFE SEAT MATERIAL

| Size   | Zinc Plated Iron |      |
|--------|------------------|------|
|        | Part #           | List |
| 1/2"   | SFGJ050MM        |      |
| 3/4"   | SFGJ075MM        |      |
| 1"     | SFGJ100MM        |      |
| 1-1/4" | SFGJ125MM        |      |
| 1-1/2" | SFGJ150MM        |      |
| 2"     | SFGJ200MM        |      |
| 2 1/2" | SFGJ250MM        |      |
| 3"     | SFGJ300MM        |      |

# GROUND JOINT

## UNIVERSAL CLAMPS

COUPLINGS +



| ZINC PLATED IRON |          |          |        |      |
|------------------|----------|----------|--------|------|
| Hose ID          | From     | To       | Part # | List |
| 3/8"             | 11/16"   | 7/8"     | SF1    |      |
|                  | 13/16"   | 15/16"   | SF2    |      |
|                  | 15/16"   | 1-1/16"  | SF4    |      |
|                  | 1-1/16"  | 1-3/16"  | SF5    |      |
|                  | 1-1/8"   | 1-5/16"  | SF9A   |      |
| 3/4"             | 1-3/16"  | 1-5/16"  | SF9U   |      |
|                  | 1-5/16"  | 1-1/2"   | SF9B   |      |
|                  | 1-1/2"   | 1-11/16" | SF10   |      |
|                  | 1-17/32" | 1-23/32" | SF14U  |      |
| 1"               | 1-11/16" | 1-15/16" | SF14   |      |
|                  | 1-25/32" | 2-3/32"  | SF19U  |      |
| 1-1/4"           | 2-3/16"  | 2-3/8"   | SF24U  |      |
| 1-1/2"           | 2-1/4"   | 2-9/16"  | SF24   |      |
|                  | 2-9/16"  | 2-3/4"   | SF25   |      |
|                  | 2-1/2"   | 2-25/32" | SF29U  |      |
| 2"               | 2-3/4"   | 3-1/16"  | SF29   |      |
|                  | 3-3/32"  | 3-7/16"  | SF30   |      |
|                  | 4-1/16"  | 4-7/16"  | SF39   |      |
| 3"               | 4-7/8"   | 5-5/16"  | SF49U  |      |
|                  | 5-1/8"   | 6-3/16"  | SF49   |      |



# FOOT VALVE / STRAINERS

## FOOT VALVES & REPLACEMENT PARTS



COUPLINGS +



| Hose Size | Foot Valves |      | Strainers |      | Neoprene Flapper Gaskets & Weight |      | Neoprene Flapper Gaskets |      | Steel Plate |      |
|-----------|-------------|------|-----------|------|-----------------------------------|------|--------------------------|------|-------------|------|
|           | Part #      | List | Part #    | List | Part #                            | List | Part #                   | List | Part #      | List |
| 1-1/2"    | FV 20B      |      | FVS 20B   |      | FVF 20B                           |      | FVG 20B                  |      | FVP 20B     |      |
| 2"        | FV 25B      |      | FVS 25B   |      | FVF 25B                           |      | FVG 25B                  |      | FVP 25B     |      |
| 2-1/2"    | FV 30B      |      | --        |      | --                                |      | --                       |      | --          |      |
| 3"        | FV 35B      |      | FVS 35B   |      | FVF 35B                           |      | FVG 35B                  |      | FVP 35B     |      |
| 4"        | FV 40B      |      | FVS 40B   |      | FVF 40B                           |      | FVG 40B                  |      | FVP 40B     |      |
| 6"        | FV 60B      |      | FVS 60B   |      | FVF 60B                           |      | FVG 60B                  |      | FVP 60B     |      |
| 8"        | FV 80B      |      | FVS 80B   |      | FVF 80B                           |      | FVG 80B                  |      | FVP 80B     |      |

## STRAINERS



| COLD ROLLED ZINC PLATED STEEL |               |      |                |      |                    |      |                        |      |                                |      |                             |      |
|-------------------------------|---------------|------|----------------|------|--------------------|------|------------------------|------|--------------------------------|------|-----------------------------|------|
| Hose Size                     | RH Round Hole |      | SH Square Hole |      | RS Round Hole Long |      | RD Round Hole Hose End |      | SKBH Skimmer Round Hole Bottom |      | SKTH Skimmer Round Hole Top |      |
|                               | Part #        | List | Part #         | List | Part #             | List | Part #                 | List | Part #                         | List | Part #                      | List |
| 1"                            | RH 10B        |      | ---            |      | RS 10B             |      | ---                    |      | ---                            |      | ---                         |      |
| 1-1/2"                        | RH 20B        |      | SH 20B         |      | RS 20B             |      | RD 20T                 |      | SK 20BH                        |      | SK 20TH                     |      |
| 2"                            | RH 25B        |      | SH 25B         |      | RS 25B             |      | RD 25T                 |      | SK 25BH                        |      | SK 25TH                     |      |
| 2-1/2"                        | RH 30B        |      | SH 30B         |      | RS 30B             |      | ---                    |      | ---                            |      | ---                         |      |
| 3"                            | RH 35B        |      | SH 35B         |      | RS 35B             |      | RD 35T                 |      | SK 35BH                        |      | SK 35TH                     |      |
| 4"                            | RH 40B        |      | SH 40B         |      | RS 40B             |      | RD 40T                 |      | ---                            |      | ---                         |      |
| 6"                            | RH 60B        |      | SH 60B         |      | RS 60B             |      | ---                    |      | ---                            |      | ---                         |      |
| 8"                            | RH 80B        |      | SH 80B         |      | RS 80B             |      | ---                    |      | ---                            |      | ---                         |      |
| 10"                           | RH 100B       |      | ---            |      | ---                |      | ---                    |      | ---                            |      | ---                         |      |
| 12"                           | RH 120B       |      | ---            |      | ---                |      | ---                    |      | ---                            |      | ---                         |      |

# STRAINERS

## POLY STRAINER



| Size   | POLYPROPYLENE |      |
|--------|---------------|------|
|        | Part #        | List |
| 1-1/2" | RH 20PP       |      |
| 2"     | RH 25PP       |      |
| 3"     | RH 35PP       |      |

## SS STRAINER - ROUNDHOLE



| Size   | 304 SS   |      |
|--------|----------|------|
|        | Part #   | List |
| 1-1/2" | RHSS 20B |      |
| 2"     | RHSS 25B |      |
| 3"     | RHSS 35B |      |
| 4"     | RHSS 40B |      |
| 6"     | RHSS 60B |      |

COUPLINGS + 

## FUNNEL STRAINER

- 304 Stainless Steel w/Built-In Buna Gasket
- To be used with female cam & groove Part 'D'

| Size | 304 SS |      |
|------|--------|------|
|      | Part # | List |
| 2"   | FS 25  |      |
| 3"   | FS 35  |      |
| 4"   | FS 40  |      |



## VISIONFLOW™ THREADED SIGHT GLASS

- Sight Glass is made from Polycarbonate material & has a temperature range from -50 to +185 F.
- 500 PSI Rating

| Size | POLYCARBONATE |      |
|------|---------------|------|
|      | Part #        | List |
| 2"   | TSG 200       |      |
| 3"   | TSG 300       |      |
| 4"   | TSG 400       |      |



Overall Length 8"  
\*DO NOT USE A WRENCH ON SIGHT GLASS\*

## ™ ASSEMBLIES



- Sight Glass is made from polycarbonate material & has a temperature range from -50 to +185 F.
- 500 PSI Rating
- Includes Strainer, Glass, A Part, D Part

| Size | ALUM/STEEL/POLYCARB |      |
|------|---------------------|------|
|      | Part #              | List |
| 2"   | SSA200AL            |      |
| 3"   | SSA300AL            |      |
| 4"   | SSA400AL            |      |

## PUMP FILTER

- Screws Into Female NPT Thread Couple



| Size   | ALUMINUM         |      |                  |      |
|--------|------------------|------|------------------|------|
|        | 1/4" Hole Part # | List | 1/2" Hole Part # | List |
| 1-1/2" | PF150AL025       |      | PF150AL050       |      |
| 2"     | PF200AL025       |      | PF200AL050       |      |
| 3"     | PF300AL025       |      | PF300AL050       |      |
| 4"     | PF400AL025       |      | PF400AL050       |      |

| Size   | 304 SS           |      |                  |      |
|--------|------------------|------|------------------|------|
|        | 1/4" Hole Part # | List | 1/2" Hole Part # | List |
| 1-1/2" | PF150SS025       |      | PF150SS050       |      |
| 2"     | PF200SS025       |      | PF200SS050       |      |
| 3"     | PF300SS025       |      | PF300SS050       |      |
| 4"     | PF400SS025       |      | PF400SS050       |      |



# BRASS FITTINGS

# PUSH ON

## GRIP-ON

▶ Used With Thermoplastic Or Rubber Push-on Style Hose Ease of assembly - push on design - Excellent vibration characteristics Plastic Protection Cap Included

### Hose x Male NPT



| Hose ID | Pipe Thread | Brass    |      |
|---------|-------------|----------|------|
|         |             | Part #   | List |
| 1/4"    | 1/8"        | 301-42   |      |
| 1/4"    | 1/4"        | 301-44   |      |
| 1/4"    | 3/8"        | 301-46   |      |
| 5/16"   | 1/8"        | 301-52   |      |
| 3/8"    | 1/8"        | 301-62   |      |
| 3/8"    | 1/4"        | 301-64   |      |
| 3/8"    | 3/8"        | 301-66   |      |
| 1/2"    | 3/8"        | 301-86   |      |
| 1/2"    | 1/2"        | 301-88   |      |
| 1/2"    | 3/4"        | 301-812  |      |
| 5/8"    | 1/2"        | 301-108  |      |
| 3/4"    | 3/4"        | 301-1212 |      |
| 1"      | 1"          | 301-1616 |      |

### Hose x FPT



| Hose ID | Pipe Thread | Brass     |      |
|---------|-------------|-----------|------|
|         |             | Part #    | List |
| 1/4"    | 1/8"        | 3099-42   |      |
| 1/4"    | 1/4"        | 3099-44   |      |
| 1/4"    | 3/8"        | ---       |      |
| 5/16"   | 1/8"        | 3099-52   |      |
| 3/8"    | 1/8"        | 3099-62   |      |
| 3/8"    | 1/4"        | 3099-64   |      |
| 3/8"    | 3/8"        | 3099-66   |      |
| 1/2"    | 3/8"        | 3099-86   |      |
| 1/2"    | 1/2"        | 3099-88   |      |
| 1/2"    | 3/4"        | 3099-812  |      |
| 5/8"    | 1/2"        | 3099-108  |      |
| 3/4"    | 3/4"        | 3099-1212 |      |
| 1"      | 1"          | 3099-1616 |      |

### Hose x 45° SAE Male



| Hose ID | Pipe Thread | Brass    |      |
|---------|-------------|----------|------|
|         |             | Part #   | List |
| 1/4"    | 1/4"        | 302-44   |      |
| 1/4"    | 5/16"       | 302-45   |      |
| 1/4"    | 3/8"        | 302-46   |      |
| 3/8"    | 3/8"        | 302-66   |      |
| 1/2"    | 1/2"        | 302-88   |      |
| 3/4"    | 3/4"        | 302-1212 |      |
| ---     | ---         | ---      |      |
| ---     | ---         | ---      |      |
| ---     | ---         | ---      |      |
| ---     | ---         | ---      |      |
| ---     | ---         | ---      |      |
| ---     | ---         | ---      |      |
| ---     | ---         | ---      |      |

### Hose x Female 45° Flare

Swivel SAE



| Hose ID | Pipe Thread | Brass    |      |
|---------|-------------|----------|------|
|         |             | Part #   | List |
| 1/4"    | 3/8"        | 307-46   |      |
| 3/8"    | 3/8"        | 307-66   |      |
| 3/4"    | 3/4"        | 307-1212 |      |
| ---     | ---         | ---      |      |
| ---     | ---         | ---      |      |
| ---     | ---         | ---      |      |
| ---     | ---         | ---      |      |
| ---     | ---         | ---      |      |
| ---     | ---         | ---      |      |
| ---     | ---         | ---      |      |
| ---     | ---         | ---      |      |
| ---     | ---         | ---      |      |
| ---     | ---         | ---      |      |

### Hose x Inverted Flare

Male, Swivel



| Hose ID | Pipe Thread | Brass    |      |
|---------|-------------|----------|------|
|         |             | Part #   | List |
| 1/4"    | 3/16"       | 305-43   |      |
| 1/4"    | 1/4"        | 305-44   |      |
| 1/4"    | 5/16"       | 305-45   |      |
| 5/16"   | 5/16"       | 305-55   |      |
| 3/8"    | 3/8"        | 305-66   |      |
| 1/2"    | 1/2"        | 305-88   |      |
| 5/8"    | 5/8"        | 305-1010 |      |

### Hose x Inverted Flare



| Hose ID | Pipe Thread | Brass    |      |
|---------|-------------|----------|------|
|         |             | Part #   | List |
| 1/4"    | 3/16"       | 306-43   |      |
| 1/4"    | 1/4"        | 306-44   |      |
| 1/4"    | 5/16"       | 306-45   |      |
| 5/16"   | 5/16"       | 306-55   |      |
| 3/8"    | 3/8"        | 306-66   |      |
| 1/2"    | 1/2"        | 306-88   |      |
| 5/8"    | 5/8"        | 306-1010 |      |

### Hose x JIC Female

Swivel 37°



| Hose ID | Pipe Thread | Brass    |      |
|---------|-------------|----------|------|
|         |             | Part #   | List |
| 1/4"    | 1/4"        | 308-44   |      |
| 1/4"    | 3/8"        | 308-46   |      |
| 3/8"    | 3/8"        | 308-66   |      |
| 1/2"    | 1/2"        | 308-88   |      |
| 3/4"    | 3/4"        | 308-1212 |      |
| 1"      | 1"          | 308-1616 |      |
| ---     | ---         | ---      |      |

### Hose x JIC Male 37°



| Hose ID | Pipe Thread | Brass    |      |
|---------|-------------|----------|------|
|         |             | Part #   | List |
| 1/4"    | 1/4"        | 310-44   |      |
| 1/4"    | 5/16"       | 310-45   |      |
| 3/8"    | 3/8"        | 310-66   |      |
| 1/2"    | 1/2"        | 310-88   |      |
| 3/4"    | 3/4"        | 310-1212 |      |
| 1"      | 1"          | 310-1616 |      |
| ---     | ---         | ---      |      |

### Hose x Hose Splicer



| Hose ID | Brass    |      |
|---------|----------|------|
|         | Part #   | List |
| 1/4"    | 304-44   |      |
| 5/16"   | 304-55   |      |
| 3/8"    | 304-66   |      |
| 1/2"    | 304-88   |      |
| 5/8"    | 304-1010 |      |
| 3/4"    | 304-1212 |      |
| 1"      | 304-1616 |      |

### Push-On Air Hose



| Hose ID | Working Pressure psi | Bend Radius | Weight Per Ft | Standard Length Ft | Black Nitrile |         |
|---------|----------------------|-------------|---------------|--------------------|---------------|---------|
|         |                      |             |               |                    | Part #        | List/Ft |
| 1/4"    | 300max               | 3.0         | 9             | 100/300'           | PH025         |         |
| 3/8"    | 300max               | 3.0         | 12            | 100/300'           | PH038         |         |
| 1/2"    | 300max               | 5.0         | 15            | 100/300'           | PH050         |         |

This oil resistant hose is excellent for use with air tools, mild chemicals and various petroleum products. Special braid angle for quick secure push-on coupling retention.  
**Temperature range:** -40° F to 212° F  
**Tube:** Black Nitrile  
**Reinforcement:** Black Neoprene  
**Cover:** One Textile Braid  
**Safety Factor:** 3:1



# BRASS FITTINGS

## HOSE SHANKS

► NPT Threads



| Hose ID | Thread Size | BRASS               |      |                       |      |                                  |      |
|---------|-------------|---------------------|------|-----------------------|------|----------------------------------|------|
|         |             | Hose End X Male NPT |      | Hose End X Female NPT |      | Female NPT Swivel End X Hose End |      |
|         |             | Part #              | List | Part #                | List | Part #                           | List |
| 1/8"    | 1/8"        | 201A-2A             |      | 209A-2A               |      | 209AS-2A                         |      |
| 3/16"   | 1/8"        | 201A-3A             |      | 209A-3A               |      | 209AS-3A                         |      |
| 3/16"   | 1/4"        | 201A-3B             |      | 209A-3B               |      | 209AS-3B                         |      |
| 1/4"    | 1/8"        | 201A-4A             |      | 209A-4A               |      | ---                              |      |
| 1/4"    | 1/4"        | 201A-4B             |      | 209A-4B               |      | 209AS-4B                         |      |
| 1/4"    | 3/8"        | 201A-4C             |      | 209A-4C               |      | ---                              |      |
| 5/16"   | 1/8"        | 201A-5A             |      | 209A-5A               |      | ---                              |      |
| 5/16"   | 1/4"        | 201A-5B             |      | 209A-5B               |      | 209AS-5B                         |      |
| 5/16"   | 3/8"        | 201A-5C             |      | 209A-5C               |      | ---                              |      |
| 3/8"    | 1/8"        | 201A-6A             |      | 209A-6A               |      | ---                              |      |
| 3/8"    | 1/4"        | 201A-6B             |      | 209A-6B               |      | 209AS-6B                         |      |
| 3/8"    | 3/8"        | 201A-6C             |      | 209A-6C               |      | 209AS-6C                         |      |
| 3/8"    | 1/2"        | 201A-6D             |      |                       |      | ---                              |      |
| 3/8"    | 3/4"        | 201A-6E             |      | 209A-6E               |      | ---                              |      |
| 1/2"    | 1/4"        | 201A-8B             |      | 209A-8B               |      | ---                              |      |
| 1/2"    | 3/8"        | 201A-8C             |      | 209A-8C               |      | 209AS-8C                         |      |
| 1/2"    | 1/2"        | 201A-8D             |      | 209A-8D               |      | 209AS-8D                         |      |
| 1/2"    | 3/4"        | 201A-8E             |      | 209A-8E               |      | ---                              |      |
| 5/8"    | 3/8"        | 201A-10C            |      | ---                   |      | ---                              |      |
| 5/8"    | 1/2"        | 201A-10D            |      | ---                   |      | ---                              |      |
| 5/8"    | 3/4"        | 201A-10E            |      | ---                   |      | ---                              |      |
| 3/4"    | 1/2"        | 201A-12D            |      | ---                   |      | ---                              |      |
| 3/4"    | 3/4"        | 201A-12E            |      | 209A-12E              |      | 209AS-12E                        |      |
| 1"      | 3/4"        | 201A-16E            |      | ---                   |      | ---                              |      |



| Hole ID | BRASS            |      |                |      |                         |      |
|---------|------------------|------|----------------|------|-------------------------|------|
|         | Hose Barb Mender |      | Hose Barb Tees |      | Male NPT X Hose Barb 90 |      |
|         | Part #           | List | Part #         | List | Part #                  | List |
| 1/8"    | HM-2             |      | ---            |      | ---                     |      |
| 3/16"   | HM-3             |      | ---            |      | HBT1-03                 |      |
| 1/4"    | HM-4             |      | HBT2-04        |      | HBT1-04                 |      |
| 5/16"   | HM-5             |      | ---            |      | ---                     |      |
| 3/8"    | HM-6             |      | HBT2-06        |      | HBT1-06                 |      |
| 1/2"    | HM-8             |      | HBT2-08        |      | HBT1-08                 |      |
| 5/8"    | HM-10            |      | ---            |      | HBT1-10                 |      |
| 3/4"    | HM-12            |      | HBT2-12        |      | HBT1-12                 |      |

COUPLINGS +





# BRASS FITTINGS

# GARDEN

## SHANK COUPLINGS - LONG SHANK



| Size<br>Hose x Thread | BRASS        |      |               |      |               |      |
|-----------------------|--------------|------|---------------|------|---------------|------|
|                       | Complete Set |      | Female        |      | Male          |      |
|                       | Part #       | List | Part #        | List | Part #        | List |
| 1/2" x 3/4" NPSH      | BLS050075    |      | BLS050075M    |      | BLS050075F    |      |
| 1/2" x 3/4" GHT       | BLS050075GHT |      | BLS050075GHTM |      | BLS050075GHTF |      |
| 5/8" x 3/4" NPSH      | BLS058075    |      | BLS058075M    |      | BLS058075F    |      |
| 5/8" x 3/4" GHT       | BLS058075GHT |      | BLS058075GHTM |      | BLS058075GHTF |      |
| 3/4" x 3/4" NPSH      | BLS075       |      | BLS075M       |      | BLS075F       |      |
| 3/4" x 3/4" GHT       | BLS075GHT    |      | BLS075GHTM    |      | BLS075GHTF    |      |
| 1" x 1" NPSH          | BLS100       |      | BLS100M       |      | BLS100F       |      |

## SHANK COUPLINGS - SHORT SHANK



| Size<br>Hose x Thread | BRASS        |      |               |      |               |      |
|-----------------------|--------------|------|---------------|------|---------------|------|
|                       | Complete Set |      | Female        |      | Male          |      |
|                       | Part #       | List | Part #        | List | Part #        | List |
| 1/2" x 3/4" NPSH      | BSS050075    |      | BSS050075M    |      | BSS050075F    |      |
| 1/2" x 3/4" GHT       | BSS050075GHT |      | BSS050075GHTM |      | BSS050075GHTF |      |
| 5/8" x 3/4" NPSH      | BSS058075    |      | BSS058075M    |      | BSS058075F    |      |
| 5/8" x 3/4" GHT       | BSS058075GHT |      | BSS058075GHTM |      | BSS058075GHTF |      |
| 3/4" x 3/4" NPSH      | BSS075       |      | BSS075M       |      | BSS075F       |      |
| 3/4" x 3/4" GHT       | BSS075GHT    |      | BSS075GHTM    |      | BSS075GHTF    |      |

## GARDEN HOSE



| Size        | HYBRID POLYMER     |      | RUBBER       |      |                |      |
|-------------|--------------------|------|--------------|------|----------------|------|
|             | Premium GardenFlex |      | Round Rubber |      | Octagon Rubber |      |
|             | Part #             | List | Part #       | List | Part #         | List |
| 5/8" x 50'  | GFH058050          |      | RGH058050    |      | ORGH058050     |      |
| 5/8" x 100' | GFH058100          |      | RGH058100    |      | ---            |      |
| 3/4" x 50'  | ---                |      | RGH075050    |      | ---            |      |
| 3/4" x 100' | ---                |      | RGH075100    |      | ---            |      |
| 1" x 50'    | ---                |      | RGH100050    |      | ---            |      |

## GARDEN HOSE NOZZLES

| Size                 | ZINC ALLOY BODY w/TPR |      |
|----------------------|-----------------------|------|
|                      | Part #                | List |
| 3/4" GHT PISTOL GRIP | PGN075                |      |



| Size           | ULC Approved Shut-Off-Plastic |      |
|----------------|-------------------------------|------|
|                | Part #                        | List |
| 3/4" GHT GREEN | 1040310                       |      |



# GARDEN

# BRASS FITTINGS

## GARDEN HOSE FITTINGS

► Garden Threads



| Garden Thread | Pipe Thread | BRASS                    |      |                                 |      |                        |      |
|---------------|-------------|--------------------------|------|---------------------------------|------|------------------------|------|
|               |             | Female GHT x Female Pipe |      | Female GHT x Female Pipe Swivel |      | Male GHT X Female Pipe |      |
|               |             | Part #                   | List | Part #                          | List | Part #                 | List |
| 3/4"          | 1/2"        | 5A-12D                   |      | 5AS-12D                         |      | 18A-12D                |      |
| 3/4"          | 3/4"        | 5A-12E                   |      | 5AS-12E                         |      | 18A-12E                |      |



| Garden Thread | Pipe Thread | BRASS                |      |                     |      |                     |      |
|---------------|-------------|----------------------|------|---------------------|------|---------------------|------|
|               |             | Male Pipe x Male GHT |      | Male GHT x Male GHT |      | Female Hose Cap GHT |      |
|               |             | Part #               | List | Part #              | List | Part #              | List |
| 3/4"          | 3/8"        | 19A-12C              |      | ---                 |      | ---                 |      |
| 3/4"          | 1/2"        | 19A-12D              |      | ---                 |      | ---                 |      |
| 3/4"          | 3/4"        | 19AF-12DE            |      | 23A-12              |      | GHN5H               |      |



19130

| Garden Thread | Hose Shank | BRASS                     |      |
|---------------|------------|---------------------------|------|
|               |            | Hose Barb x Hose Barb GHT |      |
|               |            | Part #                    | List |
| 3/4"          | 1/2"       | 202GSHS-88                |      |
| 3/4"          | 5/8"       | 202GSHS-1010              |      |
| 3/4"          | 3/4"       | 202GSHS-1212              |      |

| Details                 | BRASS                   |         |         |
|-------------------------|-------------------------|---------|---------|
|                         | STYLE                   | Part #  | List    |
|                         | 1-1/2" FNST x 3/4" MGHT | Pin Lug | 1913009 |
| 2-1/2" FNST x 3/4" MGHT | Pin Lug                 | 1913037 |         |
| 3/4" FGHT x 3/4" MNPT   | Hex                     | 2415517 |         |
| 3/4" FGHT x 1" MNPT     | Hex                     | 2415518 |         |
| 1" FNPT x 3/4" MGHT     | Hex                     | 2415520 |         |

COUPLINGS +





# BRASS FITTINGS

## FERRULES

► Sold in pkg. quantity only



### MEDIUM WEIGHT - FOR AIR & FLUID HOSE

| ID    | Length | Hole  | Metal Thickness | Cross Reference | Qty Per Pkg | BRASS      |         |
|-------|--------|-------|-----------------|-----------------|-------------|------------|---------|
|       |        |       |                 |                 |             | Part #     | List ea |
| .478" | .687"  | .328" | .025"           | 4750            | 50          | B-478-L    |         |
| .525" | .500"  | .406" | .020"           | ---             | 50          | B-525-SP10 |         |
| .560" | 1.00"  | .437" | .025"           | 7325            | 50          | B-560-SP1  |         |
| .593" | 1.00"  | .437" | .025"           | 7326            | 50          | B-593-L    |         |
| .625" | 1.00"  | .437" | .025"           | 7327            | 50          | B-625-SP4  |         |
| .656" | 1.00"  | .437" | .025"           | 7328            | 50          | B-656-L    |         |
| .690" | 1.00"  | .500" | .025"           | 7329            | 50          | B-690-L    |         |
| .718" | 1.00"  | .500" | .025"           | 7330            | 50          | B-718-SP1  |         |
| .750" | 1.00"  | .625" | .025"           | 7331            | 50          | B-750-SP3  |         |
| .781" | 1.00"  | .625" | .025"           | 7332            | 50          | B-781-SP2  |         |
| .812" | 1.00"  | .625" | .025"           | 7333            | 50          | B-812-L    |         |
| .825" | .546"  | .562" | .020"           | AA              | 50          | B-825-SP2  |         |
| .850" | .968"  | .687" | .025"           | ---             | 50          | B-850-L    |         |
| .937" | .875"  | .750" | .025"           | 7242            | 25          | B-937-L    |         |

### LIGHT WEIGHT - FOR AIR & FLUID HOSE

| ID    | Length | Hole  | Metal Thickness | Cross Reference | Qty Per Pkg | BRASS       |         |
|-------|--------|-------|-----------------|-----------------|-------------|-------------|---------|
|       |        |       |                 |                 |             | Part #      | List ea |
| .380" | .500"  | .265" | .020"           | 622             | 50          | B-380-S     |         |
| .410" | .500"  | .265" | .020"           | 620             | 50          | B-410-S     |         |
| .450" | .562"  | .343" | .020"           | 769             | 50          | B-450-SP1-S |         |
| .500" | .500"  | .343" | .020"           | 624             | 50          | B-500-SP2   |         |
| .525" | .470"  | .360" | .020"           | 625             | 50          | B-525-SP6   |         |
| .560" | .750"  | .375" | .020"           | 3588            | 50          | B-560-SP2   |         |
| .575" | .484"  | .468" | .020"           | KK              | 50          | B-575-SP1   |         |
| .600" | .500"  | .500" | .020"           | JJ              | 50          | B-600-SP2   |         |
| .625" | .500"  | .500" | .020"           | II              | 50          | B-625-SP3   |         |
| .650" | .500"  | .500" | .020"           | HH              | 50          | B-650-SP3   |         |
| .725" | .530"  | .500" | .020"           | EE              | 50          | B-725-SP3   |         |
| .750" | .531"  | .500" | .020"           | DD              | 50          | B-750-SP5   |         |

### LIGHT WEIGHT - FLUID HOSE

| ID     | Length | Hole   | Metal Thickness | Cross Reference | Qty Per Pkg | BRASS      |         |
|--------|--------|--------|-----------------|-----------------|-------------|------------|---------|
|        |        |        |                 |                 |             | Part #     | List ea |
| .875"  | .843"  | .687"  | .025"           | 7244A           | 50          | B-875-SP1  |         |
| .900"  | .875"  | .687"  | .025"           | 5029A           | 50          | B-900-SP2  |         |
| .975"  | .843"  | .687"  | .025"           | 5028A           | 50          | B-975-SP2  |         |
| 1.025" | .843"  | .687"  | .025"           | 7114A           | 50          | B-1025-SP1 |         |
| 1.050" | .843"  | .687"  | .025"           | 7145A           | 50          | B-1050-SP1 |         |
| 1.100" | .843"  | .812"  | .025"           | 5027A           | 50          | B-1100-SP2 |         |
| 1.175" | .875"  | .875"  | .025"           | 7088A           | 25          | B-1175-SP1 |         |
| 1.225" | .968"  | .875"  | .025"           | ---             | 25          | B-1225-SP1 |         |
| 1.275" | .968"  | .875"  | .025"           | ---             | 25          | B-1275-SP1 |         |
| 1.425" | .875"  | 1.062" | .025"           | ---             | 25          | B-1425-SP1 |         |
| 1.500" | .875"  | 1.125" | .025"           | ---             | 25          | B-1500-S   |         |
| 1.550" | .812"  | 1.125" | .025"           | ---             | 25          | B-1550-S   |         |



# BRASS FITTINGS

## CRIMPING TOOLS

► Our hose crimpers provide production capability & a big tool crimping advantages at just a fraction of the cost of other tools offering comparable results.

### 3041 & 3043 (Die Sizes - 3041-1 thru 3041-5 & 3048-5)

| Tool Included Dies           | Part # | List |
|------------------------------|--------|------|
| 3041-1 thru 3041-5           | 3041   |      |
| 3041-1 thru 3041-4 and 3048A | 3043   |      |

### 3042 (Capable of Die Sizes - 1/2" to 1" ID 7/8" to 1-1/2 OD)

| Tool Only - Dies Not Included             | Part # | List |
|---|--------|------|
| capable of 1/2" to 1" ID 7/8" to 1-1/2 OD | 3042   |      |

### 3041 & 3043 Dies

| Size   | Mark       | Part # | List |
|--------|------------|--------|------|
| 5/8"   | no mark, 2 | 3041-1 |      |
| 37/64" | 2, 3       | 3041-2 |      |
| 17/32" | 3, 4       | 3041-3 |      |
| 31/64" | 4, 5       | 3041-4 |      |
| 11/16" | 5, no mark | 3041-5 |      |
| 7/16"  | 7W, 7W     | 3048A  |      |
| 3/4"   | 8W, 8W     | 3049A  |      |
| 13/16" | 9W, 9W     | 3050A  |      |
| 3/8"   | 10W, 10W   | 3051A  |      |

### 3042 Dies

| Size    | Mark | Part #  | List |
|---------|------|---------|------|
| 11/16"  | 1    | 3042-1  |      |
| 23/32"  | 2    | 3042-2  |      |
| 3/4"    | 3    | 3042-3  |      |
| 25/32"  | 4    | 3042-4  |      |
| 13/16"  | 5    | 3042-5  |      |
| 27/32"  | 6    | 3042-6  |      |
| 7/8"    | 7    | 3042-7  |      |
| 29/32"  | 8    | 3042-8  |      |
| 15/16"  | 9    | 3042-9  |      |
| 31/32"  | 10   | 3042-10 |      |
| 1"      | 11   | 3042-11 |      |
| 1-1/32" | 12   | 3042-12 |      |
| 1-1/16" | 13   | 3042-13 |      |
| 1-1/8"  | 14   | 3042-14 |      |
| 1-3/16" | 15   | 3042-15 |      |
| 1-1/4"  | 16   | 3042-16 |      |
| 1-5/16" | 17   | 3042-17 |      |
| 1-3/8"  | 18   | 3042-18 |      |
| 1-7/16" | 19   | 3042-19 |      |
| 1-1/2"  | 20   | 3042-20 |      |



3041 -  
Arrangement follows:  
No mark w/Hole, 2, 3, 4,  
5, no mark no hole.

3043 -  
Arrangement follows:  
No mark w/Hole, 2, 3, 4,  
7W, 7W-w/One flat side.

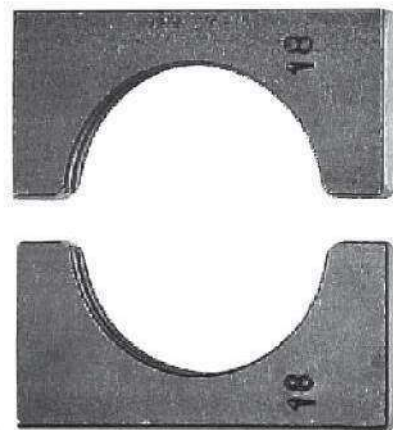
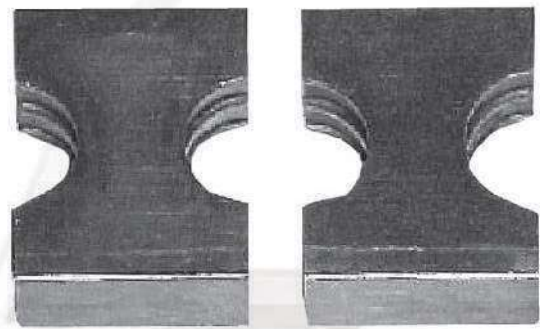



# QUICK CONNECT

# INDUSTRIAL

## SOCKETS - 1/4" BODY

Couplers shut-off when disconnected. Works w/MIL-C-4109F/A-A-59439 SYSTEMS. For use with compressed air only. Easy pull-to connect designs provides instantaneous connection of air lines.

# 1/4"

# SOCKETS

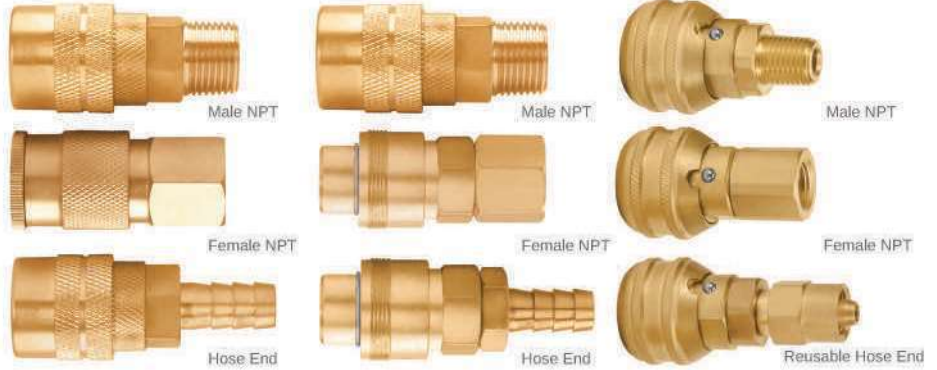

Seal material: NBR  
 Temperature Range: -40° F to 250° F  
 Working Pressure: 0 psi to 300 psi  
 4 Ball Design

| Body Size | End Size        | Over-all Dia. | Box Qty. | BRASS                  |         |      |        |          |      |                  |              |      |
|-----------|-----------------|---------------|----------|------------------------|---------|------|--------|----------|------|------------------|--------------|------|
|           |                 |               |          | Industrial Interchange |         |      |        |          |      |                  |              |      |
|           |                 |               |          | Semi-Auto              |         |      | Auto   |          |      | Auto Sleeve Lock |              |      |
|           |                 |               |          | Length                 | Part #  | List | Length | Part #   | List | Length           | Part #       | List |
| 1/4"      | 1/4" Male NPT   | .98"          | 10       | 2.05"                  | AM-02AM |      | 2.05"  | AMA-02AM |      | "                | AMASL-02AM   |      |
| 1/4"      | 1/4" Female NPT | .98"          | 10       | 1.97"                  | AM-02AF |      | 1.97"  | AMA-02AF |      | "                | AMASL-02AF   |      |
| 1/4"      | 1/4" Shank      | .98"          | 10       | 2.3"                   | AM-02AH |      | 2.3"   | AMA-02AH |      | "                | AMASL-02AHRU |      |
| 1/4"      | 3/8" Male NPT   | .98"          | 10       | 2.03"                  | AM-03AM |      | 2.09"  | AMA-03AM |      | "                |              |      |
| 1/4"      | 3/8" Female NPT | .98"          | 10       | 1.97"                  | AM-03AF |      | 1.97"  | AMA-03AF |      | "                |              |      |
| 1/4"      | 3/8" Shank      | .98"          | 10       | 2.7"                   | AM-03AH |      | 2.48"  | AMA-03AH |      | "                |              |      |
| 1/4"      | 1/2" Male NPT   | .98"          | 10       | 2.07"                  | AM-04AM |      | 2.07"  | ---      |      | ---              | ---          |      |
| 1/4"      | 1/2" Female NPT | .98"          | 10       | 2.13"                  | AM-04AF |      | 2.13"  | ---      |      | ---              | ---          |      |
| 1/4"      | 1/2" Shank      | .98"          | 10       | 2.7"                   | AM-04AH |      | 2.7"   | ---      |      | ---              | ---          |      |

## PLUGS - 1/4" BODY

Works w/MIL-C-4109F/A-A-59439 SYSTEMS. For use with compressed air only.

# 1/4"

# PLUGS



| Body Size | End Size        | BRASS                      |          |        |         |      | PLATED STEEL               |          |        |          |      | PLATED STEEL / BRASS              |          |            |        |      |
|-----------|-----------------|----------------------------|----------|--------|---------|------|----------------------------|----------|--------|----------|------|-----------------------------------|----------|------------|--------|------|
|           |                 | Industrial Interchange     |          |        |         |      |                            |          |        |          |      |                                   |          |            |        |      |
|           |                 | works w/ AM or AMA sockets |          |        |         |      | works w/ AM or AMA sockets |          |        |          |      | works w/ Auto Sleeve Lock sockets |          |            |        |      |
|           |                 | Dia.                       | Box Qty. | Length | Part #  | List | Dia.                       | Box Qty. | Length | Part #   | List | Dia.                              | Box Qty. | Length     | Part # | List |
| 1/4"      | 1/4" Male NPT   | .46"                       | 40       | 1.65"  | AN-02AM |      | .46"                       | 40       | 1.65"  | AN-02AMS |      | "                                 | "        |            |        |      |
| 1/4"      | 1/4" Female NPT | .46"                       | 40       | 1.38"  | AN-02AF |      | .46"                       | 40       | 1.38"  | AN-02AFS |      | "                                 | "        |            |        |      |
| 1/4"      | 1/4" Shank      | .46"                       | 40       | 1.89"  | AN-02AH |      | .46"                       | 40       | 1.89"  | AN-02AHS |      | "                                 | "        | AN-02AHSRU |        |      |
| 1/4"      | 3/8" Male NPT   | .46"                       | 40       | 1.69"  | AN-03AM |      | .46"                       | 40       | 1.69"  | AN-03AMS |      | "                                 | "        |            |        |      |
| 1/4"      | 3/8" Female NPT | .46"                       | 40       | 1.5"   | AN-03AF |      | .46"                       | 40       | 1.5"   | AN-03AFS |      | "                                 | "        |            |        |      |
| 1/4"      | 3/8" Shank      | .46"                       | 40       | 2.28"  | AN-03AH |      | .46"                       | 40       | 2.28"  | AN-03AHS |      | "                                 | "        |            |        |      |
| 1/4"      | 1/2" Male NPT   | .46"                       | 40       | 1.73"  | AN-04AM |      | .46"                       | 40       | 1.73"  | AN-04AMS |      | ---                               | ---      | ---        | ---    |      |
| 1/4"      | 1/2" Female NPT | .46"                       | 40       | 1.54"  | AN-04AF |      | .46"                       | 40       | 1.54"  | AN-04AFS |      | ---                               | ---      | ---        | ---    |      |
| 1/4"      | 1/2" Shank      | .46"                       | 40       | 2.28"  | AN-04AH |      | .46"                       | 40       | 2.28"  | AN-04AHS |      | ---                               | ---      | ---        | ---    |      |

# AUTOMOTIVE

# QUICK CONNECT

## SOCKETS - 1/4" BODY

► Couplers shut-off when disconnected. Works popular automotive fittings such as Amflo, Milton and others. For use with compressed **air only**. Easy pull-to-connect design provides instantaneous connection of air lines.

# 1/4"

# SOCKETS



Seal material: NBR  
 Temperature Range: -40° F to 250° F  
 Working Pressure: 0 psi to 300 psi  
 4 Ball Design

| Body Size | End Size        | BRASS |          |        |         |      |
|-----------|-----------------|-------|----------|--------|---------|------|
|           |                 | Dia.  | Box Qty. | Length | Part #  | List |
| 1/4"      | 1/4" Male NPT   | .98"  | 10       | 2.05"  | AO-02AM |      |
| 1/4"      | 1/4" Female NPT | .98"  | 10       | 1.97"  | AO-02AF |      |
| 1/4"      | 1/4" Shank      | .98"  | 10       | 0.94"  | AO-02AH |      |
| 1/4"      | 3/8" Male NPT   | .98"  | 10       | 0.82"  | AO-03AM |      |
| 1/4"      | 3/8" Female NPT | .98"  | 10       | 0.94"  | AO-03AF |      |
| 1/4"      | 3/8" Shank      | .98"  | 10       | 0.82"  | AO-03AH |      |

COUPLINGS +



## PLUGS - 1/4" BODY

► Works with popular automotive fittings such as Amflo, Milton and others. For use with compressed **air only**.

# 1/4"

# PLUGS



| Body Size | End Size        | ZINC PLATED STEEL |          |        |          |      |
|-----------|-----------------|-------------------|----------|--------|----------|------|
|           |                 | Dia.              | Hex Size | Length | Part #   | List |
| 1/4"      | 1/4" Male NPT   | .98"              | 10       | 2.05"  | AO-02PMS |      |
| 1/4"      | 1/4" Female NPT | .98"              | 10       | 1.97"  | AO-02PFS |      |
| 1/4"      | 1/4" Shank      | .98"              | 10       | 0.94"  | AO-02PHS |      |
| 1/4"      | 3/8" Male NPT   | .98"              | 10       | 0.82"  | AO-03PMS |      |
| 1/4"      | 3/8" Female NPT | .98"              | 10       | 0.94"  | AO-03PFS |      |
| 1/4"      | 3/8" Shank      | .98"              | 10       | 0.82"  | AO-03PHS |      |



# QUICK CONNECT

# PRESSURE WASHER

## PRESSURE WASHER - STRAIGHT THRU QUICK CONNECT SOCKETS

► Couplers and plugs have no internal valves so there will be maximum flow. Water use only

COUPLINGS +



SOCKET



| Body Size | End Size        | BRASS |          |        |         |  | List | Features: |
|-----------|-----------------|-------|----------|--------|---------|--|------|-----------|
|           |                 | Dia.  | Hex Size | Length | Part #  |  |      |           |
| 1/4"      | 1/4" Male NPT   | .93"  | 0.82"    | 1.73"  | 2STM2-B | - 1/4" Rated pressure 5200 psi<br>- 3/8" Rated pressure 2700 psi<br>- Temp range -40° to 250°F<br>- Standard seal Buna-n (Nitrile) |      |           |
| 1/4"      | 1/4" Female NPT | .93"  | 0.82"    | 1.48"  | 2STF2-B |  |      |           |
| 3/8"      | 3/8" Male NPT   | 1.30" | 0.94"    | 1.76"  | 3STM3-B |  |      |           |
| 3/8"      | 3/8" Female NPT | 1.20" | 0.94"    | 1.59"  | 3STF3-B |  |      |           |

## PRESSURE WASHER- STRAIGHT THRU QUICK CONNECT PLUGS

PLUG



| Body Size | End Size        | ZINC PLATED STEEL |          |        |         |  | List | Features: |
|-----------|-----------------|-------------------|----------|--------|---------|--|------|-----------|
|           |                 | Dia.              | Hex Size | Length | Part #  |  |      |           |
| 1/4"      | 1/4" Male NPT   | .61"              | 0.54"    | 1.56"  | ST2M2-S | - 1/4" Rated pressure 5200 psi<br>- 3/8" Rated pressure 2700 psi<br>- Temp range -40° to 250°F |      |           |
| 1/4"      | 1/4" Female NPT | .75"              | 0.67"    | 1.45"  | ST2F2-S |  |      |           |
| 3/8"      | 3/8" Male NPT   | .68"              | 0.67"    | 1.70"  | ST3M3-S |  |      |           |
| 3/8"      | 3/8" Female NPT | .95"              | 0.86"    | 1.64"  | ST3F3-S |  |      |           |

## PRESSURE WASHER ASSEMBLIES

► There is a bend retractor on each end with male solid by male swivel.

| 3000 PSI | Body Size | Length                 | End Size               | Part #       | List |
|----------|-----------|------------------------|------------------------|--------------|------|
|          | 3/8"      | 50'                    | Coupled w/ Male X Male | PW30003850CL |      |
| 100'     |           | Coupled w/ Male X Male | PW300038100CL          |              |      |
| 1/2"     | 50'       | Coupled w/ Male X Male | PW30005050CL           |              |      |
|          | 100'      | Coupled w/ Male X Male | PW300050100CL          |              |      |

| 4000 PSI | Body Size | Length                 | End Size               | Part #       | List |
|----------|-----------|------------------------|------------------------|--------------|------|
|          | 3/8"      | 50'                    | Coupled w/ Male X Male | PW40003850CL |      |
| 100'     |           | Coupled w/ Male X Male | PW400038100CL          |              |      |
| 1/2"     | 50'       | Coupled w/ Male X Male | PW40005050CL           |              |      |
|          | 100'      | Coupled w/ Male X Male | PW400050100CL          |              |      |

| 6000 PSI | Body Size | Length                 | End Size               | Part #       | List |
|----------|-----------|------------------------|------------------------|--------------|------|
|          | 3/8"      | 50'                    | Coupled w/ Male X Male | PW60003850CL |      |
| 100'     |           | Coupled w/ Male X Male | PW600038100CL          |              |      |
| 1/2"     | 50'       | Coupled w/ Male X Male | PW60005050CL           |              |      |
|          | 100'      | Coupled w/ Male X Male | PW600050100CL          |              |      |



## COUPLINGS



| Body Size | End Size                         | Part # | List |
|-----------|----------------------------------|--------|------|
| 3/8"      | 3/8" Female X 22mm X 14mm Swivel | PWC38  |      |



For Blue Pressure Washer hose, please see p. 231

# ACCESSORIES

# PNEUMATIC

## RECOIL AIR HOSE - NYLON (Yellow)

► Temperature range:  
-20°F to 180°F  
WP: 200psi



| ID   | Swivel & Rigid NPT Thread | Length/Ft | Part # | List |
|------|---------------------------|-----------|--------|------|
| 1/4" | 1/4"                      | 12        | N2512  |      |
|      | 1/4"                      | 25        | N2525  |      |
|      | 1/4"                      | 50        | N2550  |      |
| 3/8" | 3/8"                      | 12        | N3812  |      |
|      | 3/8"                      | 25        | N3825  |      |
|      | 3/8"                      | 50        | N3850  |      |
|      | ---                       | ---       | ---    |      |
|      | ---                       | ---       | ---    |      |

## RECOIL AIR HOSE - POLYURETHANE (Blue)

► Temperature range: -20°F to 180°F  
WP: 120psi



| ID   | Swivel & Rigid NPT Thread | Length/Ft | Part #  | List |
|------|---------------------------|-----------|---------|------|
| 1/4" | 1/4"                      | 10        | P2510   |      |
|      | 1/4"                      | 20        | P2520   |      |
|      | 1/4"                      | 30        | P2530   |      |
| 3/8" | 3/8"                      | 10        | P3810   |      |
|      | 3/8" x 1/4"               | 10        | P382510 |      |
|      | 3/8"                      | 20        | P3820   |      |
|      | 3/8" x 1/4"               | 20        | P382520 |      |
|      | 3/8"                      | 30        | P3830   |      |
|      | 3/8" x 1/4"               | 30        | P382530 |      |

COUPLINGS +



## INDUSTRIAL AIR/WATER HOSE ASSEMBLY (Red)

► Working pressure ratings are based on ambient temperature of 70° F & will vary inversely w/Temperature changes.

Construction:  
- Cover EPDM / SBR mix compound  
- Tube NBR / SBR Mix compound rubber



| ID   | Male NPT | Working PSI | Burst PSI | Length/Ft | Part # | List |
|------|----------|-------------|-----------|-----------|--------|------|
| 3/8" | 1/4"     | 200         | 600       | 25'       | PA2525 |      |
| 3/8" | 1/4"     | 200         | 600       | 50'       | PA2550 |      |

## AIRSHIELD INDUSTRIAL AIR/WATER HOSE

► Flexible, lightweight handling w/Strain relief sleeves.



Brass Couplings  
Both Ends 1/4" NPT

| ID   | Length/ Ft | Working PSI | Red Part #   | Blue Part #    | List |
|------|------------|-------------|--------------|----------------|------|
| 1/4" | 25'        | 300         | SFASP 025-25 | SFASPBL 025-25 |      |
|      | 50'        | 300         | SFASP 025-50 | SFASPBL 025-50 |      |
| 3/8" | 25'        | 300         | SFASP 038-25 | SFASPBL 038-25 |      |
|      | 50'        | 300         | SFASP 038-50 | SFASPBL 038-50 |      |
| 1/2" | 25'        | 300         | SFASP 050-25 | SFASPBL 050-25 |      |
|      | 50'        | 300         | SFASP 050-50 | SFASPBL 050-50 |      |

## HOSE REELS

Open Spring-Driven Reels  
Epoxy Coated Steel



| Size | Length | Hose Included | Working PSI | Pressure | Part #     | List |
|------|--------|---------------|-------------|----------|------------|------|
| 1/2" | 50'    | Yes           | 300         | Low      | 5HR-342-GH |      |
|      | 35'    | Yes           | 300         | Med      | 5HR-232    |      |
| 3/8" | 50'    | Yes           | 300         | Med      | 5HR-242    |      |

## BLOW GUNS - 1/4"

| ID              | Part # | List |
|-----------------|--------|------|
| Safety Blow Gun | AR-905 |      |



| ID                  | Part #   | List |
|---------------------|----------|------|
| Rubber Tip Blow Gun | AR-905-C |      |



| ID                   | Part #   | List |
|----------------------|----------|------|
| Booster Tip Blow Gun | AR-905-A |      |





# HYDRAULICS

# QUICK CONNECT

## TYPE A - HYDRAULIC SOCKETS

► Designed to meet ISO 7241-A standard.

Material: Carbon Steel  
 Seal Material: Buna-N(Nitrile)  
 Surface treatment: Zinc plating



Interchangeable with:  
 - Parker 6600  
 - Snap-Tite 61  
 - Aeroquip 5600 (FD65)

### CARBON STEEL

| Body Size | End Size        | Over-all Length | Over-all Diameter | Hex Size | Working Pressure | Working Temperature | Part #     | List |
|-----------|-----------------|-----------------|-------------------|----------|------------------|---------------------|------------|------|
| 1/4"      | 1/4" Female NPT | 47mm / 1.85"    | 25mm / .98"       | 19mm     | 5075 psi         | -4°F to +176°F      | HQD-04-AFS |      |
| 3/8"      | 3/8" Female NPT | 57mm / 2.24"    | 31mm / 1.22"      | 22mm     | 4350 psi         | -4°F to +176°F      | HQD-06-AFS |      |
| 1/2"      | 1/2" Female NPT | 66mm / 2.59"    | 38mm / 1.49"      | 27mm     | 4350 psi         | -4°F to +176°F      | HQD-08-AFS |      |
| 3/4"      | 3/4" Female NPT | 82.5mm / 3.24"  | 54mm / 2.12"      | 34mm     | 3625 psi         | -4°F to +176°F      | HQD-12-AFS |      |
| 1"        | 1" Female NPT   | 117mm / 4.60"   | 70mm / 2.75"      | 41mm     | 2900 psi         | -4°F to +176°F      | HQD-16-AFS |      |

## TYPE A - HYDRAULIC PLUGS

► Designed to meet ISO 7241-A standard.



Interchangeable with:  
 - Parker 6600  
 - Snap-Tite 61  
 - Aeroquip 5600 (FD65)

### CARBON STEEL

| Body Size | End Size        | Over-all Length | Over-all Diameter | Hex Size | Working Pressure | Working Temperature | Part #     | List |
|-----------|-----------------|-----------------|-------------------|----------|------------------|---------------------|------------|------|
| 1/4"      | 1/4" Female NPT | 35mm / 1.37"    | 20mm / .78"       | 19mm     | 5075 psi         | -4°F to +176°F      | HQD-04-AMS |      |
| 3/8"      | 3/8" Female NPT | 39mm / 1.53"    | 26mm / 1.02"      | 22mm     | 4350 psi         | -4°F to +176°F      | HQD-06-AMS |      |
| 1/2"      | 1/2" Female NPT | 44mm / 1.73"    | 32mm / 1.25"      | 27mm     | 4350 psi         | -4°F to +176°F      | HQD-08-AMS |      |
| 3/4"      | 3/4" Female NPT | 55mm / 2.16"    | 37mm / 1.45"      | 34mm     | 3625 psi         | -4°F to +176°F      | HQD-12-AMS |      |
| 1"        | 1" Female NPT   | 75mm / 2.95"    | 46mm / 1.81"      | 41mm     | 2900 psi         | -4°F to +176°F      | HQD-16-AMS |      |

## TYPE A - APPLICATIONS

► This series couplings are used in a wide range of hydraulic applications including construction equipment, manufacturing machinery, and in-plant systems. They can be found anywhere the fluid transfer lines need to be connected and disconnected for operation or maintenance of equipment.

Rugged construction makes these couplings a good choice for mobile applications including dump trucks, snow plows, refuse hauling, mining, asphalt paving, truck trailer connections and many more. In-plant machinery applications include hydraulic fluid, chemicals and gas lines for paper mills, steel production, and many varieties of plant maintenance and production equipment.

Seal Fast ISO A Quick Connects/Disconnects are double shut-off couplings used widely where frequent connection and disconnection of fluid lines are needed. They are a general purpose coupling recommended for use with mobile hydraulics, machine tools, plastic molding and test equipment applications.



# QUICK CONNECT

# HYDRAULICS

## TYPE B - HYDRAULIC SOCKETS

► Designed to meet ISO 7241-B standard.

Material: Carbon Steel  
 Seal Material: Buna-N(Nitrile)  
 Surface treatment: Zinc plating

SOCKETS  
 TYPE B



Interchangeable with:  
 - Parker 60  
 - Snap-Tite 72  
 - Aeroquip FD45

COUPLINGS +



| CARBON STEEL |                 |                 |                   |          |                  |                     |            |      |
|--------------|-----------------|-----------------|-------------------|----------|------------------|---------------------|------------|------|
| Body Size    | End Size        | Over-all Length | Over-all Diameter | Hex Size | Working Pressure | Working Temperature | Part #     | List |
| 1/4"         | 1/4" Female NPT | 47mm / 1.85"    | 25mm / .98"       | 19mm     | 5075 psi         | -4°F to +176°F      | HQD-04-BFS |      |
| 3/8"         | 3/8" Female NPT | 57mm / 2.24"    | 31mm / 1.22"      | 22mm     | 4350 psi         | -4°F to +176°F      | HQD-06-BFS |      |
| 1/2"         | 1/2" Female NPT | 66mm / 2.59"    | 38mm / 1.49"      | 27mm     | 4350 psi         | -4°F to +176°F      | HQD-08-BFS |      |
| 3/4"         | 3/4" Female NPT | 82.5mm / 3.24"  | 54mm / 2.12"      | 34mm     | 3625 psi         | -4°F to +176°F      | HQD-12-BFS |      |
| 1"           | 1" Female NPT   | 117mm / 4.60"   | 70mm / 2.75"      | 41mm     | 2900 psi         | -4°F to +176°F      | HQD-16-BFS |      |

## TYPE B - HYDRAULIC PLUGS

► Designed to meet ISO 7241-B standard.

PLUGS



Interchangeable with:  
 - Parker 60  
 - Snap-Tite 72  
 - Aeroquip FD45

| CARBON STEEL |                 |                 |                   |          |                  |                     |            |      |
|--------------|-----------------|-----------------|-------------------|----------|------------------|---------------------|------------|------|
| Body Size    | End Size        | Over-all Length | Over-all Diameter | Hex Size | Working Pressure | Working Temperature | Part #     | List |
| 1/4"         | 1/4" Female NPT | 35mm / 1.37"    | 20mm / .78"       | 19mm     | 5075 psi         | -4°F to +176°F      | HQD-04-BMS |      |
| 3/8"         | 3/8" Female NPT | 39mm / 1.53"    | 26mm / 1.02"      | 22mm     | 4350 psi         | -4°F to +176°F      | HQD-06-BMS |      |
| 1/2"         | 1/2" Female NPT | 44mm / 1.73"    | 32mm / 1.25"      | 27mm     | 4350 psi         | -4°F to +176°F      | HQD-08-BMS |      |
| 3/4"         | 3/4" Female NPT | 55mm / 2.16"    | 37mm / 1.45"      | 34mm     | 3625 psi         | -4°F to +176°F      | HQD-12-BMS |      |
| 1"           | 1" Female NPT   | 75mm / 2.95"    | 46mm / 1.81"      | 41mm     | 2900 psi         | -4°F to +176°F      | HQD-16-BMS |      |

## TYPE B - APPLICATIONS

► This series couplings are used in a wide range of hydraulic applications including construction equipment, manufacturing machinery, and in-plant systems. They can be found anywhere the fluid transfer lines need to be connected and disconnected for operation or maintenance of equipment.

Rugged construction makes these couplings a good choice for mobile applications including dump trucks, snow plows, refuse hauling, mining, asphalt paving, truck trailer connections and many more. In-plant machinery applications include hydraulic fluid, chemicals and gas lines for paper mills, steel production, and many varieties of plant maintenance and production equipment.

Seal Fast ISO B Quick Connects/Disconnects are double shut-off couplings used widely where frequent connection and disconnection of fluid lines are needed. They are a general purpose coupling recommended for use with mobile hydraulics, machine tools, plastic molding and test equipment applications.



# HYDRAULICS

# QUICK CONNECT

## FLAT FACE - HYDRAULIC SOCKETS

► Designed to meet ISO 16208.

Material: Carbon Steel  
 Seal Material: Buna-N(Nitrile)  
 Surface treatment: Zinc plating



Interchangeable with:  
 - Parker FEM  
 - Snap-Tite 74  
 - Aeroquip FD89  
 - Stucchi A

### CARBON STEEL

| Body Size | End Size        | Over-all Length | Over-all Diameter | Hex Size | Working Pressure | Working Temperature | Part #    | List |
|-----------|-----------------|-----------------|-------------------|----------|------------------|---------------------|-----------|------|
| 1/4"      | 1/4" Female NPT | 47mm / 1.85"    | 25mm / .98"       | 19mm     | 5075 psi         | -4°F to +176°F      | FFQD-04-F |      |
| 3/8"      | 3/8" Female NPT | 57mm / 2.24"    | 31mm / 1.22"      | 22mm     | 4350 psi         | -4°F to +176°F      | FFQD-06-F |      |
| 1/2"      | 1/2" Female NPT | 66mm / 2.59"    | 38mm / 1.49"      | 27mm     | 4350 psi         | -4°F to +176°F      | FFQD-08-F |      |
| 3/4"      | 3/4" Female NPT | 82.5mm / 3.24"  | 54mm / 2.12"      | 34mm     | 3625 psi         | -4°F to +176°F      | FFQD-12-F |      |
| 1"        | 1" Female NPT   | 117mm / 4.60"   | 70mm / 2.75"      | 41mm     | 2900 psi         | -4°F to +176°F      | FFQD-16-F |      |

## FLAT FACE - HYDRAULIC PLUGS

► Designed to meet ISO 16208.



Interchangeable with:  
 - Parker FEM  
 - Snap-Tite 74  
 - Aeroquip FD89  
 - Stucchi A

### CARBON STEEL

| Body Size | End Size        | Over-all Length | Over-all Diameter | Hex Size | Working Pressure | Working Temperature | Part #    | List |
|-----------|-----------------|-----------------|-------------------|----------|------------------|---------------------|-----------|------|
| 1/4"      | 1/4" Female NPT | 35mm / 1.37"    | 20mm / .78"       | 19mm     | 5075 psi         | -4°F to +176°F      | FFQD-04-M |      |
| 3/8"      | 3/8" Female NPT | 39mm / 1.53"    | 26mm / 1.02"      | 22mm     | 4350 psi         | -4°F to +176°F      | FFQD-06-M |      |
| 1/2"      | 1/2" Female NPT | 44mm / 1.73"    | 32mm / 1.25"      | 27mm     | 4350 psi         | -4°F to +176°F      | FFQD-08-M |      |
| 3/4"      | 3/4" Female NPT | 55mm / 2.16"    | 37mm / 1.45"      | 34mm     | 3625 psi         | -4°F to +176°F      | FFQD-12-M |      |
| 1"        | 1" Female NPT   | 75mm / 2.95"    | 46mm / 1.81"      | 41mm     | 2900 psi         | -4°F to +176°F      | FFQD-16-M |      |

## FLAT FACE - APPLICATIONS

► Seal Fast Flat Face (Flush Face) Quick Connects/Disconnects are made according to ISO 16028 interchange specifications. They have a no-drip valve design to minimize fluid loss allowing for a safer and cleaner environment. These are also ideal where dirt is frequently exposed to the connection points. The female features a sleeve lock safety device to help reduce the chance of accidental disconnect.



# QUICK CONNECT

# HYDRAULICS

## WING NUT - HYDRAULIC SOCKETS

Material: Brass & Carbon Steel  
 Seal Material: Buna-N(Nitrile)  
 Surface treatment: Zinc plating

SOCKETS



Interchangeable with:  
 - Parker 6100  
 - Snap-Tite 78  
 - Aeroquip 5100  
 - Dixon W

COUPLINGS +



| CARBON STEEL |                   |                 |                  |          |                  |                     |           |      |
|--------------|-------------------|-----------------|------------------|----------|------------------|---------------------|-----------|------|
| Body Size    | End Size          | Over-all Length | Wrench Flat Size | Wing Nut | Working Pressure | Working Temperature | Part #    | List |
| 3/4"         | 3/4" Female NPT   | 3.57"           | 1.43"            | 4.38"    | 2900 psi         | -4°F to +176°F      | WNQD-12-F |      |
| 1"           | 1" Female NPT     | 3.87"           | 1.43"            | 4.38"    | 2900 psi         | -4°F to +176°F      | WNQD-16-F |      |
| 1-1/4"       | 1-1/4" Female NPT | 4.16"           | 1.78"            | 5.20"    | 2900 psi         | -4°F to +176°F      | WNQD-20-F |      |

## WING NUT - HYDRAULIC PLUGS

PLUGS



Interchangeable with:  
 - Parker 6100  
 - Snap-Tite 78  
 - Aeroquip 5100  
 - Dixon W

| CARBON STEEL |                 |                 |                  |          |                  |                     |           |      |
|--------------|-----------------|-----------------|------------------|----------|------------------|---------------------|-----------|------|
| Body Size    | End Size        | Over-all Length | Wrench Flat Size | Hex Size | Working Pressure | Working Temperature | Part #    | List |
| 3/4"         | 3/4" Male NPT   | 3.57"           | 1.43"            | 1.88"    | 2900 psi         | -4°F to +176°F      | WNQD-12-M |      |
| 1"           | 1" Male NPT     | 3.55"           | 1.56"            | 1.88"    | 2900 psi         | -4°F to +176°F      | WNQD-16-M |      |
| 1-1/4"       | 1-1/4" Male NPT | 3.71"           | 1.88"            | 2.13"    | 2900 psi         | -4°F to +176°F      | WNQD-20-M |      |

## WING NUT - APPLICATIONS

Seal Fast Wing Nut Quick Connects/Disconnects are low spill couplings designed to allow connection under pressure. They are recommended for oil well equipment, sand and salt spreaders, live bottom trailers, dump trailers, etc.





## THREADS

### Iron Pipe Thread Abbreviations

|          |                |          |                  |
|----------|----------------|----------|------------------|
| <b>N</b> | National       | <b>F</b> | Fuels            |
| <b>P</b> | Pipe           | <b>S</b> | Straight Thread  |
| <b>T</b> | Tapered Thread | <b>M</b> | Mechanical Joint |

## THREAD TYPES

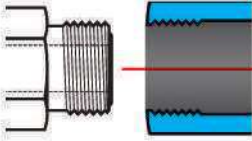

**Straight Thread** – Straight thread run parallel. Port Fittings & Adapter fittings using straight thread require use of an O-ring Boss Seal technique to seal against leakage. (NPSC – American Standard Straight Coupling Pipe Thread are the standards for Straight Thread in the US.)  
**Seal Method** = O-Ring or Bonded Washer

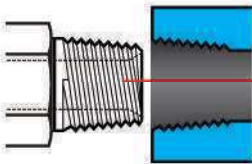

**Tapered Thread** – Tapered thread typically uses a 2° angle on the threads allowing the threads to interfere & seal off. Threads must be clean & precise. Pipe Fittings with Tapered Thread don't use O-rings, but rather must use compounds or Teflon Tape to help seal the threads. (National Pipe Thread Taper (NPT) is a U.S. standard for tapered threads used on threaded pipes & fittings.)  
**Seal Method** = Metal-to-Metal

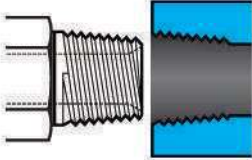

**NPTF** – National Pipe threads are similar in function to BSP threads, but are not generally interchangeable. NPTF threads are also known as Dryseal. Controlled truncation of threads mean the metal-to-metal thread seal is at root and crest of threads, in addition to flanks of threads.  
**Seal Method** = Metal-to-Metal

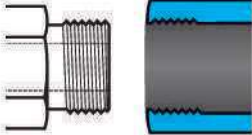

**NPSM** – National pipe straight thread for mechanical joint. This is used on the female swivel nut of iron pipe swivel adapters. The leak-resistant joint is not made by the sealing fit of threads, but by a tapered seat in the coupling end.  
**Seal Method** = O-Ring or Bonded Washer

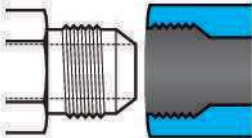

**JIC 37** – JIC male has 37° flare which seals against 37° seat in female. JIC male can also seal against 37° flared tubing with JIC nut and sleeve. JIC male can also be used with RYCO 5134 J-Lok Female Nut and Flareless Olive on Imperial OD tubing.  
**Seal Method** = O-Ring or Bonded Washer

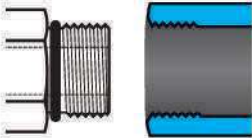

**ORB** – O Ring Boss seals with ORing compressed between hex boss of UN male and 12°/15° tapered bore of UN (O Ring Boss) female port. For elbows and tees, Backup Washer and Lock Nut allow orientation of fitting to required direction.  
**Seal Method** = Metal-to-Metal

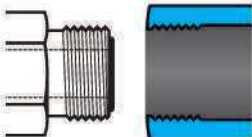

**ORFS** – ORFS system consists of ORFS Male with O Ring in Face, which seals against Flat Seated ORFS Female Swivel Nut fitting. The Swivel Nut can be slipped back to help installation in tight situations. The prominent position of the O Ring on the Male fitting makes it easy to inspect the condition of the O Ring.  
**Seal Method** = O-Ring or Bonded Washer

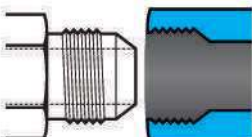

**SAE 45** – SAE male has 45° flare which seals against 45° seat in female. Male can also seal against 45° flared tubing with nut and sleeve. 7/16 - 20, 1/2 - 20, 3/4 - 16 & 7/8 - 14 are the same thread form as JIC 37° flare. Some fittings in these sizes have both JIC 37° & SAE 45° seats.  
**Seal Method** = Metal-to-Metal

### Acronyms Definitions

|               |                                     |
|---------------|-------------------------------------|
| <b>NPT</b>    | National Pipe Thread                |
| <b>FPT</b>    | Female Pipe Thread                  |
| <b>MPT</b>    | Male Pipe Thread                    |
| <b>NPTF</b>   | National Pipe Taper Fuel (Dryseal)  |
| <b>NPSM</b>   | National Pipe Straight Mechanical   |
| <b>JIC 37</b> | Joint Industry Commission 37°       |
| <b>ORB</b>    | O Ring Boss                         |
| <b>ORFS</b>   | O Ring Face Seal                    |
| <b>SAE 45</b> | Society of Automotive Engineers 45° |

| COMPATIBILITY | NPTF |
|---------------|------|
| MALE NPTF     | ●    |
| FEMALE NPTF   | ●    |
| MALE NPSM     | ●    |
| FEMALE NPSM   | ●    |
| MALE JIC 37   |      |
| FEMALE JIC 37 |      |
| MALE ORB      |      |
| FEMALE ORB    |      |
| MALE ORFS     |      |
| FEMALE ORFS   |      |
| MALE SAE 45   |      |
| FEMALE SAE 45 |      |





**NPTF**



**NPSM**



**JIC 37**



**ORB**



**ORFS**



# THREADS TYPES

| NPSM | JIC 37 | ORB | ORFS | SAE 45 |
|------|--------|-----|------|--------|
| •    |        |     |      |        |
| •    |        |     |      |        |
| •    |        |     |      |        |
| •    |        |     |      |        |
|      | •      |     |      |        |
|      | •      |     |      |        |
|      |        | •   |      |        |
|      |        | •   |      |        |
|      |        |     | •    |        |
|      |        |     | •    |        |
|      |        |     |      | •      |
|      |        |     |      | •      |



# HYDRAULICS

# COUPLINGS

## NPTF MALE - RIGID

COUPLINGS +



RIGID  
NPTF

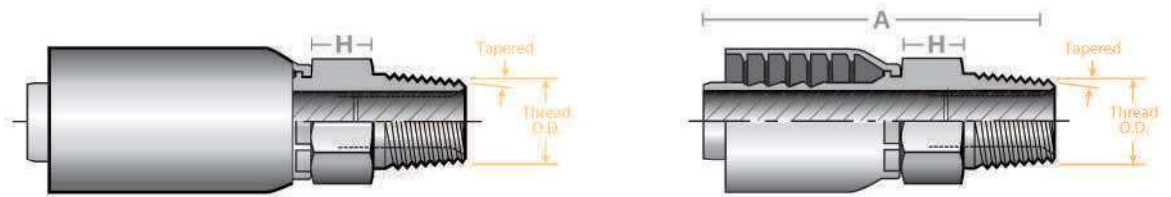

| NPTF Male |                 | COMPRESSION TYPE |          |      |       | BITE TO WIRE |             |      |  |
|-----------|-----------------|------------------|----------|------|-------|--------------|-------------|------|--|
| ID        | Thread          | H                | Part #   | List | A     | H            | Part #      | List |  |
| 1/4"      | 1/8" - 27       | 9/16"            | MP-04-02 |      | 1.80" | 9/16"        | 10143-04-02 |      |  |
| 1/4"      | 1/4" - 18       | 9/16"            | MP-04-04 |      | 2.01" | 9/16"        | 10143-04-04 |      |  |
| 1/4"      | 3/8" - 18       | 11/16"           | MP-04-06 |      | ---   | ---          | ---         |      |  |
| 3/8"      | 1/4" - 18       | 3/4"             | MP-06-04 |      | ---   | ---          | ---         |      |  |
| 3/8"      | 3/8" - 18       | 3/4"             | MP-06-06 |      | 2.37" | 3/4"         | 10143-06-06 |      |  |
| 3/8"      | 1/2" - 14       | 7/8"             | MP-06-08 |      | ---   | ---          | ---         |      |  |
| 1/2"      | 3/8" - 18       | 7/8"             | MP-08-06 |      | ---   | ---          | ---         |      |  |
| 1/2"      | 1/2" - 14       | 7/8"             | MP-08-08 |      | 2.84" | 7/8"         | 10143-08-08 |      |  |
| 5/8"      | 1/2" - 14       | 15/16"           | MP-10-08 |      | 3.04" | 15/16"       | 10143-10-08 |      |  |
| 3/4"      | 3/4" - 14       | 1-1/8"           | MP-12-12 |      | 3.09" | 1-1/16"      | 10143-12-12 |      |  |
| 1"        | 1" - 11-1/2     | 1-3/8"           | MP-16-16 |      | 2.59" | 1-3/8"       | 10143-16-16 |      |  |
| 1-1/4"    | 1 1/4" - 11-1/2 | 1-11/16"         | MP-20-20 |      | 4.08" | 1-3/4"       | 10143-20-20 |      |  |
| 1-1/2"    |                 | ---              | ---      |      | 3.50" | 2"           | 10143-24-24 |      |  |
| 2"        |                 | ---              | ---      |      | 4.05" | 2-1/2"       | 10143-32-32 |      |  |

## NPTF MALE - SWIVEL

SWIVEL  
NPTF

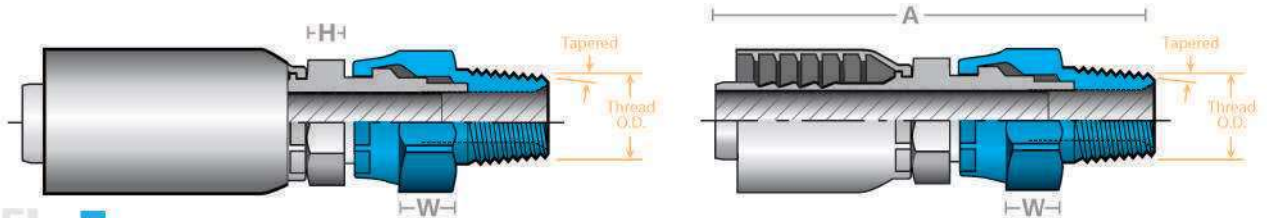

| NPTF Male |             | COMPRESSION TYPE |        |           |      | BITE TO WIRE |      |             |      |
|-----------|-------------|------------------|--------|-----------|------|--------------|------|-------------|------|
| ID        | Thread      | H                | W      | Part #    | List | A            | H    | Part #      | List |
| 1/4"      | 1/8" - 27   | 9/16"            | 5/8"   | MPX-04-02 |      | ---          | ---  | ---         |      |
| 1/4"      | 1/4" - 18   | 9/16"            | 5/8"   | MPX-04-04 |      | ---          | ---  | ---         |      |
| 3/8"      | 3/8" - 18   | 11/16"           | 3/4"   | MPX-06-06 |      | 3.08"        | 3/4" | 11343-06-06 |      |
| 3/8"      | 1/2" - 14   | 3/4"             | 7/8"   | MPX-06-08 |      | ---          | ---  | ---         |      |
| 1/2"      | 1/2" - 14   | 13/16"           | 7/8"   | MPX-08-08 |      | ---          | ---  | ---         |      |
| 5/8"      | 1/2" - 14   | 15/16"           | 7/8"   | MPX-10-08 |      | ---          | ---  | ---         |      |
| 3/4"      | 3/4" - 14   | 1-1/8"           | 1-1/8" | MPX-12-12 |      | ---          | ---  | ---         |      |
| 1"        | 1" - 11-1/2 | 1-3/8"           | 1-3/8" | MPX-16-16 |      | ---          | ---  | ---         |      |

# COUPLINGS

# HYDRAULICS

## NPTF MALE - 90° SWIVEL

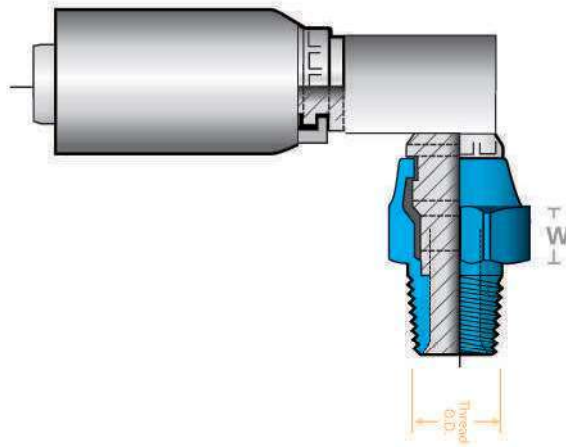

SWIVEL  
NPTF

| Male NPTF |          | PLATED STEEL |             |      |
|-----------|----------|--------------|-------------|------|
| ID        | Thread   | W            | Part #      | List |
| 1/2"      | 3/4 - 14 | 1.1/4"       | MPX90-08-12 |      |

COUPLINGS +



## NPSM FEMALE - SWIVEL

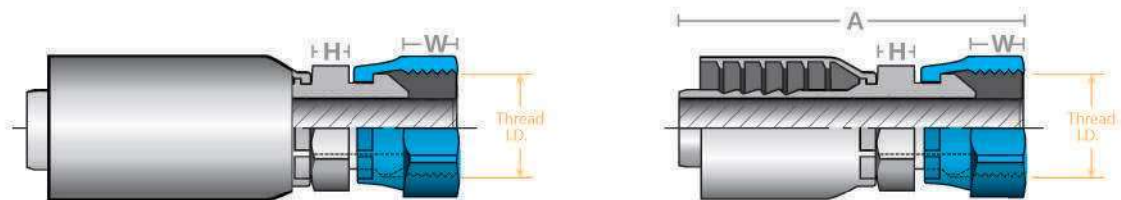

SWIVEL  
NPSM

| NPSM Female |          | PLATED STEEL |        |           |      |
|-------------|----------|--------------|--------|-----------|------|
| ID          | Thread   | H            | W      | Part #    | List |
| 1/4"        | 1/4 - 18 | 11/16"       | 9/16"  | FPX-04-04 |      |
| 3/8"        | 3/8 - 18 | 7/8"         | 11/16" | FPX-06-06 |      |
| 1/2"        | 1/2 - 14 | ---          | ---    | ---       |      |
| 1/2"        | 1/2 - 14 | 1"           | 7/8"   | FPX-08-08 |      |
| 3/4"        | 3/4 - 14 | 1-1/4"       | 1-1/8" | FPX-12-12 |      |

| BITE TO WIRE |       |     |             |      |
|--------------|-------|-----|-------------|------|
| A            | H     | W   | Part #      | List |
| ---          | ---   | --- | ---         |      |
| 2.32"        | 5/16" | 1"  | 10843-08-08 |      |
| ---          | ---   | --- | ---         |      |



# HYDRAULICS

# COUPLINGS

## JIC 37° MALE - RIGID

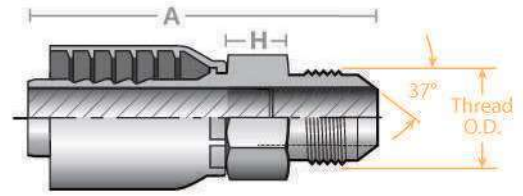
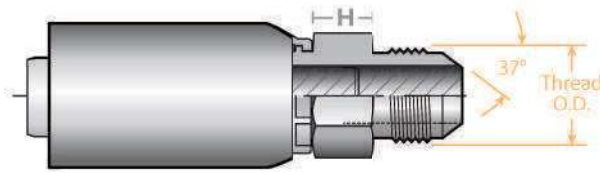

RIGID  
JIC 37°

### PLATED STEEL

| JIC 37° Male |               | COMPRESSION TYPE |          |      | BITE TO WIRE |        |             |      |
|--------------|---------------|------------------|----------|------|--------------|--------|-------------|------|
| ID           | Thread        | H                | Part #   | List | A            | H      | Part #      | List |
| 1/4"         | 7/16" - 20"   | 9/16"            | MJ-04-04 |      | 1.99"        | 9/16"  | 10343-04-04 |      |
| 1/4"         | 1/2" - 20"    | 9/16"            | MJ-04-05 |      | ---          | ---    | ---         |      |
| 3/8"         | 9/16" - 18"   | 11/16"           | MJ-06-06 |      | 2.36"        | 3/4"   | 10343-06-06 |      |
| 3/8"         | 3/4" - 16"    | 3/4"             | MJ-06-08 |      | ---          | ---    | ---         |      |
| 1/2"         | 3/4" - 16"    | 7/8"             | MJ-08-08 |      | 2.68"        | 7/8"   | 10343-08-08 |      |
| 1/2"         | 7/8" - 14"    | 7/8"             | MJ-08-10 |      | ---          | ---    | ---         |      |
| 5/8"         | 1/2" - 14     | 15/16"           | MJ-10-08 |      | 3.03"        | 15/16" | 10343-10-10 |      |
| 3/4"         | 1 5/8" - 12"  | 1-3/8"           | MJ-12-12 |      | 3.19"        | 1-1/8" | 10343-12-12 |      |
| 1"           | 1 5/16" - 12" | 1-3/8"           | MJ-16-16 |      | 3.68"        | 1-3/8" | 10343-16-16 |      |

## JIC 37° FEMALE - SWIVEL

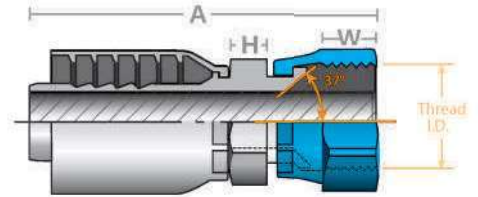
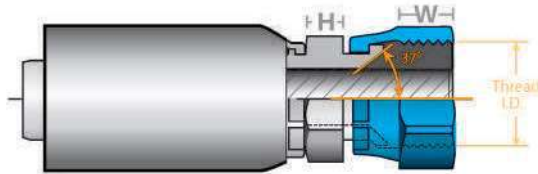

SWIVEL  
JIC 37°

### PLATED STEEL

| JIC 37° Female |              | COMPRESSION TYPE |        |           |      | BITE TO WIRE |         |        |             |      |
|----------------|--------------|------------------|--------|-----------|------|--------------|---------|--------|-------------|------|
| ID             | Thread       | H                | W      | Part #    | List | A            | H       | W      | Part #      | List |
| 1/4"           | 7/16" - 20   | 9/16"            | 9/16"  | FJX-04-04 |      | 1.94"        | 9/16"   | 9/16"  | 10643-04-04 |      |
| 1/4"           | 1/2" - 20    | 9/16"            | 5/8"   | FJX-04-05 |      | ---          | ---     | ---    | ---         |      |
| 1/4"           | 9/16" - 18   | 9/16"            | 11/16" | FJX-04-06 |      | ---          | ---     | ---    | ---         |      |
| 3/8"           | 9/16" - 18   | 11/16"           | 11/16" | FJX-06-06 |      | 2.29"        | 11/16"  | 11/16" | 10643-06-06 |      |
| 3/8"           | 3/4" - 16    | 11/16"           | 7/8"   | FJX-06-08 |      | ---          | ---     | ---    | ---         |      |
| 1/2"           | 3/4" - 16    | 13/16"           | 7/8"   | FJX-08-08 |      | 2.77"        | 13/16"  | 7/8"   | 10643-08-08 |      |
| 1/2"           | 7/8" - 14    | 7/8"             | 1"     | FJX-08-10 |      | 2.85"        | 7/8"    | 1"     | 10643-08-10 |      |
| 5/8"           | 3/4" - 16    | 15/16"           | 7/8"   | FJX-10-08 |      | 2.82"        | 15/16"  | 7/8"   | 10643-10-08 |      |
| 5/8"           | 7/8" - 14    | 15/16"           | 1"     | FJX-10-10 |      | 2.93"        | 15/16"  | 1"     | 10643-10-10 |      |
| 3/4"           | 1 1/16" - 12 | 1-1/8"           | 1-1/4" | FJX-12-12 |      | 3.17"        | 1-1/16" | 1-1/4" | 10643-12-12 |      |
| 3/4"           | 1 5/16" - 12 | 1-3/8"           | 1-1/2" | FJX-12-16 |      | ---          | ---     | ---    | ---         |      |
| 1"             | 1 5/16" - 12 | 1-3/8"           | 1-1/2" | FJX-16-16 |      | 3.62"        | 1-3/8"  | 1-1/2" | 10643-16-16 |      |
| 1 1/4"         | 1 5/8" - 12  | 1-11/16"         | 2"     | FJX-20-20 |      | 3.94"        | 1-7/8"  | 2"     | 10643-20-20 |      |
| 1-1/2"         | 1 7/8" - 12  | ---              | ---    | ---       |      | 3.84"        | 2-1/8"  | 2-1/4" | 10643-24-24 |      |
| 2"             | 2-1/2" - 12  | ---              | ---    | ---       |      | 4.73"        | 2-1/2"  | 2-7/8" | 10643-32-32 |      |

# COUPLINGS

# HYDRAULICS

## JIC 37° FEMALE - 45° SWIVEL

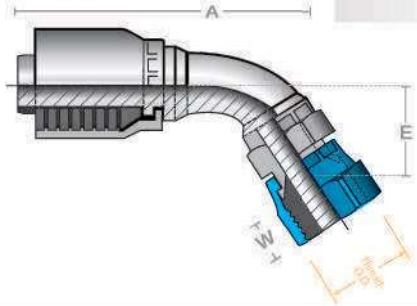
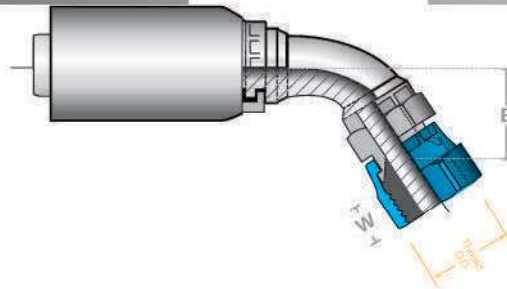

SWIVEL  
JIC 37°

### PLATED STEEL

| JIC 37° Female |              | COMPRESSION TYPE |        |             |      | BITE TO WIRE |        |       |             |      |
|----------------|--------------|------------------|--------|-------------|------|--------------|--------|-------|-------------|------|
| ID             | Thread       | W                | E      | Part #      | List | A            | W      | E     | Part #      | List |
| 1/4"           | 7/16" - 20   | 0.45"            | 9/16"  | FJX45-04-04 |      | 1.96"        | 9/16"  | .39"  | 13743-04-04 |      |
| 1/4"           | 9/16" - 18   | 1.5"             | 11/16" | FJX45-04-06 |      | 2.23"        | 11/16" | .39"  | 13743-04-06 |      |
| 3/8"           | 9/16" - 18   | 0.59"            | 11/16" | FJX45-06-06 |      | 2.39"        | 11/16" | .39"  | 13743-06-06 |      |
| 3/8"           | 3/4" - 16    | 0.713"           | 7/8"   | FJX45-06-08 |      | 2.74"        | 7/8"   | .55"  | 13743-06-08 |      |
| 1/2"           | 3/4" - 16    | 0.635"           | 1"     | FJX45-08-08 |      | 2.83"        | 7/8"   | .55"  | 13743-08-08 |      |
| 1/2"           | 7/8" - 14    | 0.839"           | 1"     | FJX45-08-10 |      | 2.93"        | 1"     | .63"  | 13743-08-10 |      |
| 5/8"           | 7/8" - 14    | ---              | ---    | ---         |      | 3.17"        | 1"     | .63"  | 13743-10-10 |      |
| 5/8"           | 1 1/16" - 12 | ---              | ---    | ---         |      | 3.62"        | 1-1/4" | .83"  | 13743-10-12 |      |
| 3/4"           | 1 1/16" - 12 | 1.118"           | 1 1/4" | FJX45-12-12 |      | 3.63"        | 1-1/4" | .78"  | 13743-12-12 |      |
| 1"             | 1 5/16" - 12 | 1.059"           | 1 1/2" | FJX45-16-16 |      | 4.34"        | 1-1/2" | .95"  | 13743-16-16 |      |
| 1 1/4"         | 1 5/8" - 12  | ---              | ---    | ---         |      | 4.59"        | 2"     | 1.19" | 13743-20-20 |      |
| 1 1/2"         | 1 7/8" - 12  | ---              | ---    | ---         |      | 5.50"        | 2-1/4" | 1.47" | 13743-24-24 |      |

## JIC 37° FEMALE - 90° SWIVEL

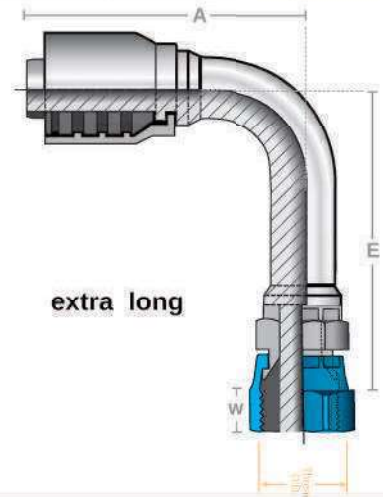
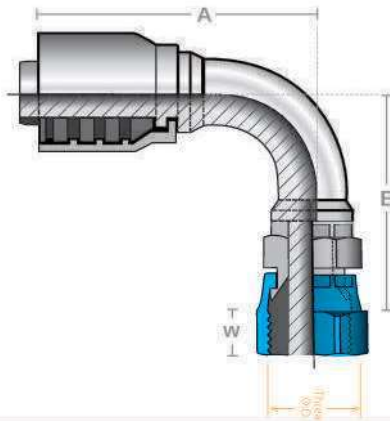
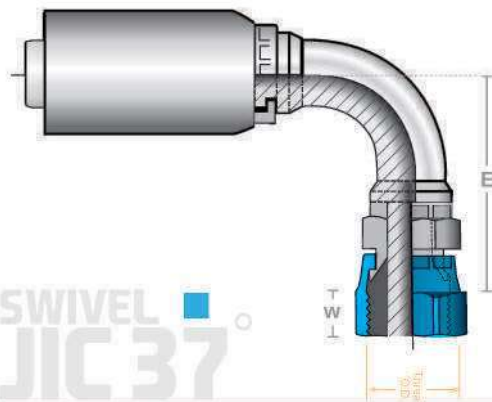

SWIVEL  
JIC 37°

### PLATED STEEL

| JIC 37° Female |              | COMPRESSION TYPE |        |             |      | BITE TO WIRE |        |       |             |      | BITE TO WIRE (extra long) |        |       |              |      |
|----------------|--------------|------------------|--------|-------------|------|--------------|--------|-------|-------------|------|---------------------------|--------|-------|--------------|------|
| ID             | Thread       | W                | B      | Part #      | List | A            | W      | E     | Part #      | List | A                         | W      | E     | Part #       | List |
| 1/4"           | 7/16" - 20   | 1.80"            | 9/16"  | FJX90-04-04 |      | 1.78"        | 9/16"  | .83"  | 13943-04-04 |      | 1.96"                     | 9/16"  | 1.81" | FJX90L-04-04 |      |
| 1/4"           | 9/16" - 18   | 2.18"            | 11/16" | FJX90-04-06 |      | ---          | ---    | ---   | ---         |      | ---                       | ---    | ---   | ---          |      |
| 3/8"           | 9/16" - 18   | 2.18"            | 11/16" | FJX90-06-06 |      | 2.21"        | 11/16" | .91"  | 13943-06-06 |      | 2.27"                     | 11/16" | 2.18" | FJX90L-06-06 |      |
| 3/8"           | 3/4" - 16    | 2.50"            | 7/8"   | FJX90-06-08 |      | ---          | ---    | ---   | ---         |      | ---                       | ---    | ---   | ---          |      |
| 1/2"           | 3/4" - 16    | 2.50"            | 7/8"   | FJX90-08-08 |      | 2.62"        | 7/8"   | 1.14" | 13943-08-08 |      | 2.62"                     | 7/8"   | 2.52" | FJX90L-08-08 |      |
| 1/2"           | 7/8" - 14    | 2.75"            | 1"     | FJX90-08-10 |      | ---          | ---    | ---   | ---         |      | ---                       | ---    | ---   | ---          |      |
| 5/8"           | 7/8" - 14    | ---              | ---    | ---         |      | 2.97"        | 1"     | 1.26" | 13943-10-10 |      | ---                       | ---    | ---   | ---          |      |
| 3/4"           | 1 1/16" - 12 | 2.75"            | 1"     | FJX90-12-12 |      | 3.49"        | 1-1/4" | 1.89" | 13943-12-12 |      | 3.49"                     | 1-1/4" | 3.74" | FJX90L-12-12 |      |
| 1"             | 1 5/16" - 12 | 3.75"            | 1 1/4" | FJX90-16-16 |      | 4.28"        | 1-1/2" | 2.20" | 13943-16-16 |      | ---                       | ---    | ---   | ---          |      |
| 1 1/4"         | 1 5/8" - 12  | ---              | ---    | ---         |      | 4.43"        | 2"     | 2.59" | 13943-20-20 |      | ---                       | ---    | ---   | ---          |      |
| 1 1/2"         | 1 7/8" - 12  | ---              | ---    | ---         |      | 5.50"        | 2-1/4" | 3.81" | 13943-24-24 |      | ---                       | ---    | ---   | ---          |      |
| 2"             | 2 1/2" - 12  | ---              | ---    | ---         |      | 6.75"        | 2-7/8" | 4.62" | 13943-32-32 |      | ---                       | ---    | ---   | ---          |      |





# HYDRAULICS

# COUPLINGS

## ORB MALE - RIGID

COUPLINGS +

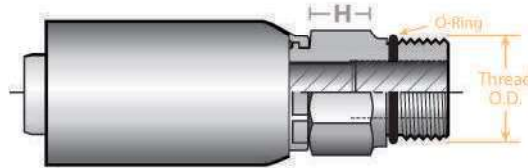

RIGID  
ORB

| ORB Male |            | PLATED STEEL<br>COMPRESSION TYPE |          |      |
|----------|------------|----------------------------------|----------|------|
| ID       | Thread     | H                                | Part #   | List |
| 1/4"     | 7/16" - 20 | 9/16"                            | MB-04-04 |      |
| 1/4"     | 9/16" - 18 | 11/16"                           | MB-04-06 |      |
| 3/8"     | 9/16" - 18 | 11/16"                           | MB-06-06 |      |
| 3/8"     | 3/4" - 16  | 7/8"                             | MB-06-08 |      |
| 1/2"     | 3/4" - 16  | 7/8"                             | MB-08-08 |      |
| 1/2"     | 7/8" - 14  | 1"                               | MB-08-10 |      |

## ORB MALE - SWIVEL

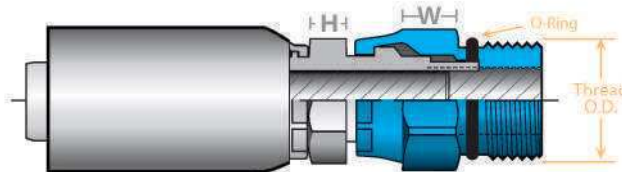

SWIVEL  
ORB

| ORB Male |            | PLATED STEEL<br>COMPRESSION TYPE |      |           |      |
|----------|------------|----------------------------------|------|-----------|------|
| ID       | Thread     | H                                | W    | Part #    | List |
| 1/4"     | 7/16" - 20 | 9/16"                            | 5/8" | MBX-04-04 |      |
| 3/8"     | 9/16" - 18 | 11/16"                           | 3/4" | MBX-06-06 |      |
| 3/8"     | 3/4" - 16  | 7/8"                             | 7/8" | MBX-06-08 |      |
| 1/2"     | 3/4" - 16  | 7/8"                             | 7/8" | MBX-08-08 |      |
| 1/2"     | 7/8" - 14  | 1"                               | 1"   | MBX-08-10 |      |